



---

**Operating instructions**

---

**Series SX602**

**Alphanumeric large size displays  
with Ethernet interface**

MAC address:

		:			:			:			:			:			:		
--	--	---	--	--	---	--	--	---	--	--	---	--	--	---	--	--	---	--	--

Site of the unit:

---

Germany  
Siebert Industrieelektronik GmbH  
Siebertstrasse, D-66571 Eppelborn  
Phone +49 (0) 6806 980-0, Fax +49 (0) 6806 980-999  
www.siebert.de, info@siebert.de

France  
Siebert France Sarl  
33 rue Poincaré, BP 90 334, F-57203 Sarreguemines Cédex  
Phone +33 (0) 3 87 98 63 68, Fax +33 (0) 3 87 98 63 94  
www.siebert.fr, info@siebert.fr

Austria  
Siebert Österreich GmbH  
Karl-Eybl-Strasse 4, Postfach 19, A-2435 Ebergassing  
Phone +43 (0) 2234 795 25, Fax +43 (02234) 795 26  
www.siebert-oesterreich.at, info@siebert-oesterreich.at

Switzerland  
Siebert AG  
Bützbergstrasse 2, Postfach 91, CH-4912 Aarwangen  
Phone +41 (0) 62 922 18 70, Fax +41 (0) 62 922 33 37  
www.siebert.ch, info@siebert.ch

© Siebert Industrieelektronik GmbH

Siebert® and LRD® are registered trademarks of Siebert Industrieelektronik GmbH All other product names mentioned herein may be the trademarks or registered trademarks of their respective owners.

Subject to change. – All rights reserved, including the rights of translation. No part of this document may in any form or by any means (print, photocopy, microfilm or any other process) be reproduced or by using electronic systems be processed, copied, or distributed without our written permission.

---

**Table of contents**

---

Chapter 1	Safety precautions	<ul style="list-style-type: none"> <li>Important information</li> <li>Safety</li> <li>Intended use</li> <li>Mounting and installation</li> <li>Battery replacement</li> <li>Grounding</li> <li>EMC measures</li> <li>Disposal</li> </ul>
Chapter 2	Unit description	<ul style="list-style-type: none"> <li>Model designation</li> <li>Unit construction</li> <li>Display range</li> <li>Principle circuit diagram</li> <li>Central Processing Unit</li> <li>Ethernet interface</li> <li>Function inputs</li> <li>Menu display</li> <li>Status indicator</li> <li>Ethernet LEDs</li> <li>Battery</li> <li>Power supply</li> </ul>
Chapter 3	Character display	<ul style="list-style-type: none"> <li>LED matrix</li> <li>Character sets</li> <li>Proportional lettering</li> <li>PC-Tool</li> <li>LED color</li> </ul>
Chapter 4	Control	<ul style="list-style-type: none"> <li>Parameterization</li> <li>Ethernet interface</li> <li>Text types</li> <li>Automatic line break</li> <li>Automatic paging</li> <li>Activation commands</li> <li>Command table</li> <li>Online texts</li> <li>Static texts</li> <li>Initial text</li> <li>Inserting variables</li> <li>Deleting text</li> <li>Forced line break</li> <li>Flashing</li> <li>Marquee text</li> <li>Character set</li> <li>LED color</li> <li>Inserting time/date</li> <li>Bar graph</li> <li>\$ character</li> <li>Brightness</li> <li>Blanking</li> <li>Reset</li> <li>Setting time/date</li> <li>Reading out time/date</li> </ul>

Chapter 5	Parameterization	<ul style="list-style-type: none"> <li>Menu display</li> <li>Menu operation</li> <li>Menu table</li> <li>Time-out</li> <li>Initial text</li> <li>Paging interval</li> <li>Charater set</li> <li>Language</li> <li>Display test</li> <li>Network parameters</li> <li>Time/date</li> </ul>
Chapter 6	Configuration	<ul style="list-style-type: none"> <li>MAC Address</li> <li>Basic configuration</li> <li>Configuration via network</li> <li>Additional information</li> <li>Basic setting</li> </ul>
Chapter 7	Status messages	<ul style="list-style-type: none"> <li>Fault messages</li> </ul>
Chapter 8	Character table	
Chapter 9	Technical data	<ul style="list-style-type: none"> <li>Unit properties</li> <li>Housing colors</li> <li>Front frame</li> <li>Ambient conditions</li> <li>Max. Power consumption</li> <li>Fixed text memory</li> <li>Real-time clock</li> </ul>
Chapter 10	Unit measurements and weights	<ul style="list-style-type: none"> <li>Units with one-sided display and character height of 50 and 100 mm</li> <li>Units with double-sided display and character height of 50 and 100 mm</li> <li>Units with one-side display and character height of 160 and 250 mm</li> <li>Units with double-sided display and character height of 160 and 250 mm</li> </ul>

**Important information**

Read these operating instructions before starting the unit. They provide you with important information on the use, safety and maintenance of the units. This helps you to protect yourself and prevent damage to the unit.



Information intended to help you to avoid death, bodily harm or considerable damage to property are highlighted by the warning triangle shown here; it is imperative that this information be properly heeded.

The operating instructions are intended for trained professional electricians familiar with the safety standards of electrical technology and industrial electronics.

Store these operating instructions in an appropriate place.

The manufacturer is not liable if the information in these operating instructions are not complied with.

**Safety**

Components inside the units are energized with electricity during operation. For this reason, mounting and maintenance work may only be performed by professionally-trained personnel while observing the corresponding safety regulations.

The repair and replacement of components and modules may only be carried out by the manufacturer for safety reasons and due to the required compliance with the documented unit properties.

The units do not have a power switch. They are operative as soon as the operating voltage is applied.

**Intended use**

The units are intended for use in industrial environments. They may only be operated within the limit values stipulated by the technical data.

When configuring, installing, maintaining and testing the units, the safety and accident-prevention regulations relevant to use in each individual case must be complied with.

Trouble-free, safe operation of the units requires proper transport, storage, installation, mounting and careful operation and maintenance of the units.

**Mounting and installation**

The attachment options for the units were conceived in such a way as to ensure safe, reliable mounting.



The user must ensure that the attachment hardware, the unit carrier and the anchoring at the unit carrier are sufficient to securely support the unit under the given surrounding conditions.

The units are to be mounted in such a way that they can be opened up while mounted. Sufficient space for the cables must be available in the unit near the cable infeed.

Sufficient space is to be kept clear around the units to ensure air circulation and to prevent the build-up of heat resulting from use. The relevant information must be heeded in the case of units ventilated by other means.



When the housing fasteners are opened, the front frame of the housing hinges out upward or downward (depending on the unit version) automatically.

**Battery replacement** The units have a lithium battery used for data security of the real-time clock. The battery can explode if replaced improperly.

**Grounding** All devices are equipped with a metal housing. They comply with safety class I and require a protective earth connection. The connecting cable for the operating voltage must contain a protective earth wire of a sufficient cross section (DIN VDE 0106 part 1, DIN VDE 0411 part 1).

**EMV-measures** The devices comply with the EU Directive 89/336/EEC (EMC Directive) and provide the required interference immunity. Observe the following when connecting the operating voltage and data cables:

- Use shielded data cables.
- The data and operating voltage cables must be laid separately. They may not be laid together with heavy-current cables or other interference-producing cables.
- The cable thickness must be properly assessed (DIN VDE 0100 Part 540).
- The cable lengths inside the units are to be kept as short as possible to prevent interference. This applies especially to unshielded operating voltage cables. Shielded cables are also to be kept short due to any interference which might be emitted by the shielding.
- Neither excessively long cables nor cable loops may be placed inside the units.
- The connection of the cable shielding to the functional ground (PE) must be as short and low-impedance as possible. It should be made directly to the mounting plate over a large area with a conductive clip:

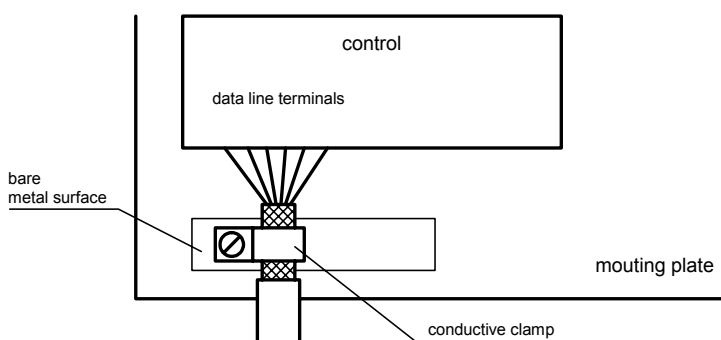

- The cable shielding is to be connected at both cable ends. If equipotential bonding currents are expected due to the cable arrangement, electrical isolation is to be performed on one side. In this case, capacitive connection (approx. 0.1µF/600 V AC) of the shielding on the isolated side must occur.

**Disposal** Units or unit parts which are no longer needed are to be disposed of in accordance with the regulations in effect in your country.

**Model designation**

The model designation of the units is:

SX602-xxx/xx/xx-xxx/xx-E0

x = The 'x's in the model designation indicate the size and design of the units (see Chapter 9).

**Unit construction**

The following figure shows model type SX602-10/10/xx-xxx/xx-xx as example for the other model types. The front frame of the housing is locked with quick-action releases and can be hinged downward for opening the unit.

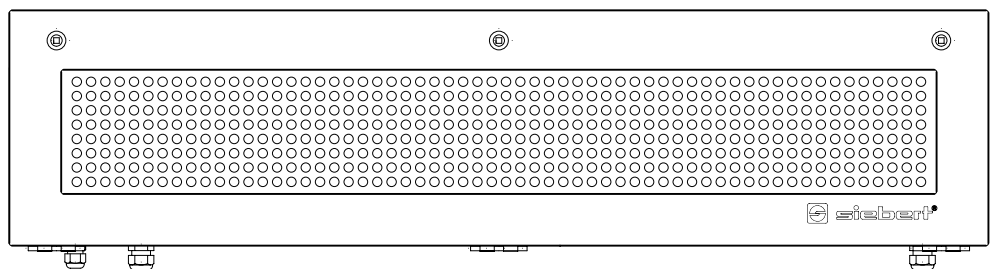

The following figure shows the unit when open and reveals the modular construction of the units. All components, controls and connections are directly accessible.

The display modules (LED matrix modules) are found inside the housing front frame. The control computer and power supply unit are located in the lower housing section.

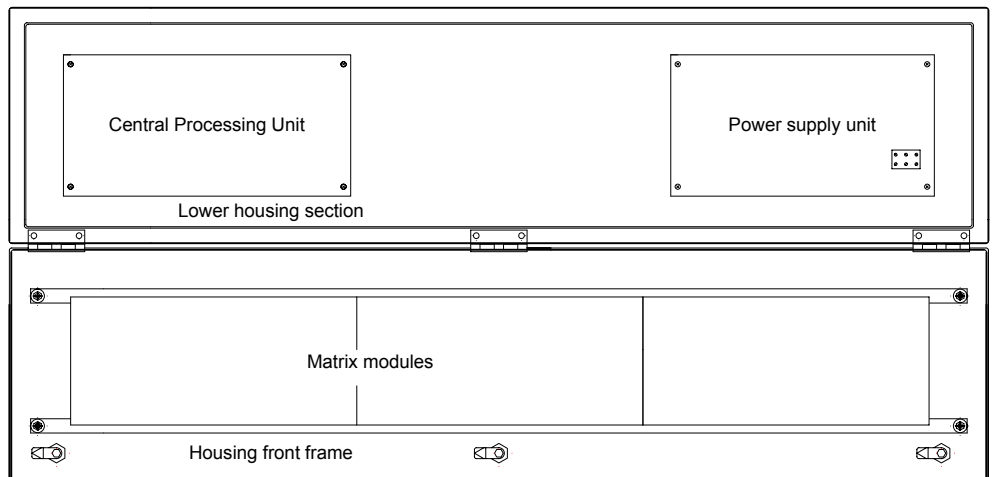

**Display range**

The series SX602 includes devices with the following display range:

- Character height 160 mm: 4, 6, 8, 10 and 12 characters
- Character height 250 mm: 4, 6 and 8 characters

The devices with double-sided display (SX602-xxx/xx/xx-2xx/xx-xx) show the same information on the front and rear side.

Principle circuit diagram

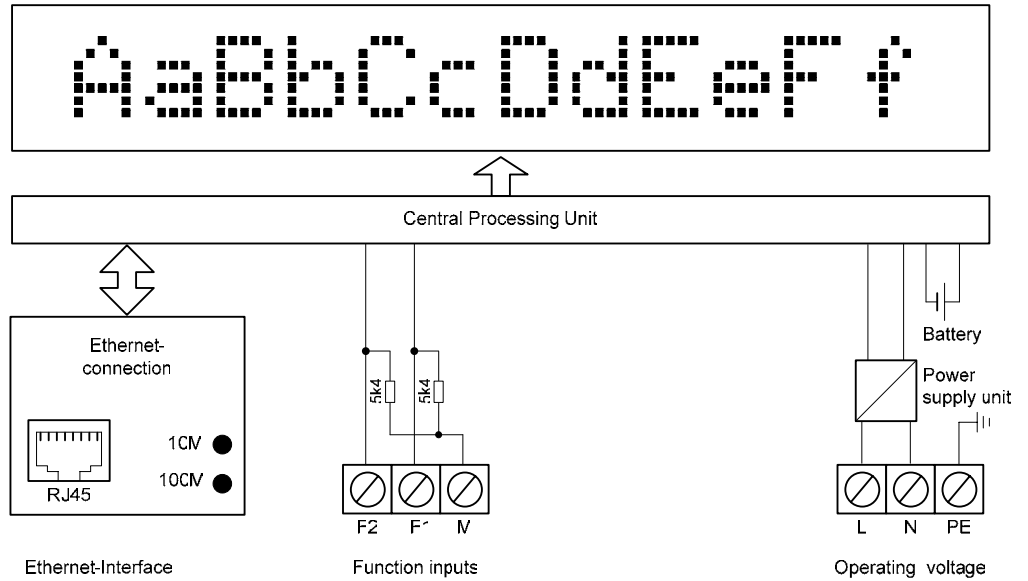

Central Processing Unit

The following figure shows the Central Processing Unit:

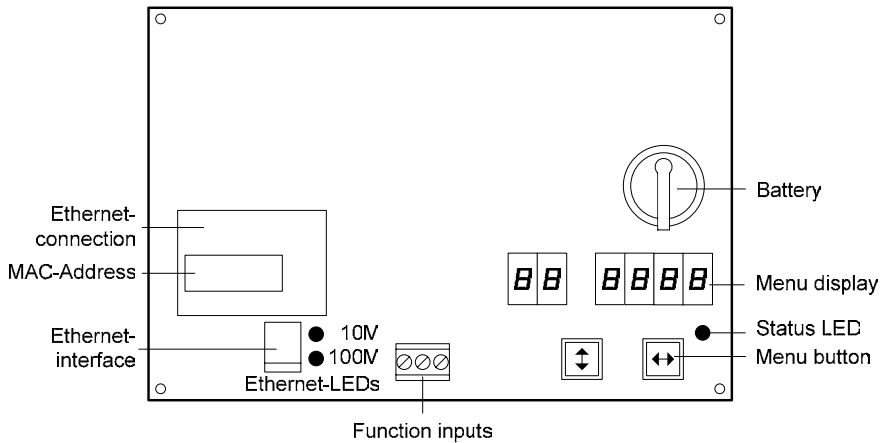

Ethernet interface

The Ethernet interface is used for activation of the devices. It is a standard-RJ45 socket and has the following specifications:

- Data rate: 10/100 Mbps, Automatic detection
- Galvanic separation: 1,5 kV
- Supported protocols: ICMP, ARP, IP, TCP, UDP, DHCP, Telnet and HTTP
- Operation modes: TCP Server, TCP Client and UDP

The units are set-up as TCP server by default. The data is transmitted to port 8000 via a socket connection.

**Configuration:** The basic configuration can be set up without external aids via the menu (see chapter 5). Further settings can be done via Web Browser or Telnet console (see chapter 4).

The Telnet and HTTP protocols are used exclusively for configuration, not for data transmission.



Function inputs	<p>The function inputs allow, independently of commands via the Ethernet interface, a reduction the brightness and the flashing of the display (see chapter 4). They are located on a screw-type terminal strip.</p> <p>The function inputs are PLC-compatible and are designed for the following signal voltages:</p> <p>Signal voltage: L = -3.5...+5 V (open input = L) H = +18...30 V (active H), M = reference potential</p>
Menu display	<p>The parameterization of the devices is carried out in a menu of the menu display.</p> <p>In normal operation, the following status messages appear in the menu display::</p> <p><b>Online</b> Data are received at the interface. <b>DATA</b> The device detects a telegram ending. ----- No data are received at the interface.</p> <p>In programming operation, the following status messages appear in the menu display:</p> <p><b>LOAD</b> Static texts are loaded in the text memory. <b>READ</b> Static texts are read from the text memory.</p>
Status indicator	<p>The data LED illuminates when data is being received.</p>
Ethernet-LEDs	<p>The data transmission rate is detected automatically and displayed via the 100M and 10M Ethernet LEDs. A permanently lit LED signals a connection having the indicated speed. Flickering means additional data exchange.</p>
Battery	<p>The lithium battery (type CR2032) provides a power reserve for the real-time clock. It is located in a battery holder, thus making battery replacement easy. The battery is to be replaced with a new one after three years.</p>
Power supply	<p>The power supply of the devices (230 V AC) is connected to the terminals L, N and PE.</p>

LED-matrix

The characters are displayed on an LED matrix.

Character sets

The character sets Acala 7 and Acala 7 extended are permanently installed in the units.

Charater set	Character display
Acala 7	AaBbCcDdEeF fGgHhIiJjKkLlMmNnOoPpQqRr
Acala 7 extended*	ÀáBbCcDdEeF fGgHhIi

Proportional font

The character sets Acala 7 and Acala 7 extended are represented in non-proportional font. The same number of pixels is available for the width of each character.

The character set Acala 7 P, which is preinstalled ex factory and contained on the data medium, represents the characters in proportional font. Each character uses the width it requires visually.

PC-Tool

The data carrier also contains the PC tool 'Font Manager' for installing the character sets. In addition to that, the tool is used for creating user-defined character sets, for saving character sets on data carriers and for restoring the installed character sets.

LED color

The device models SX602-xx/xx/xR-xxx/xx-xx and SX602-xx/xx/xG-xxx/xx-xx have a display with red and/or green LED color. The LED color cannot be changed (monochrome display).

The device models SX602-xx/xx/xM-xxx/xx-xx have a display the LED color of which can be switched between red, green and orange.

---

**Chapter 4** **Control**

---

Parameterization                      The units must be parameterized before they can be controlled. Parameterization occurs in a menu (see Chapter 5).

Ethernet interface                      The devices are activated via the Ethernet interface (see chapter 2).

Text types                                The devices can display both dynamic and static texts:

- Dynamic texts can be changed while the unit is running. They are generated from within the process and sent to the display via the Ethernet interface.
- Static texts cannot be changed while the unit is running. They are compiled using the PC tool 'Text Manager' delivered on data carrier and loaded in the text memory via the Ethernet interface. After that, they can be opened via their text number.

Automatic line break                    If the text contains more characters than can be displayed in one line, a line break is inserted automatically at the end of the line, and the text is continued in the next line.

Automatic paging                        If the text contains more characters than can be displayed in the display, it will be automatically displayed in paging mode.

Interfacing commands                   The interfacing of the devices is done using commands according to the following command table. In the following description of the commands, the numbers in [ ] refer to the corresponding lines in the command table.

Single commands need a message termination (↵) with the characters CR, LF or CR/LF.

Command table

**Commands for text manipulation**

Display dynamic text	<code>cc...↵</code>	Transmission of any characters	[1]
Display fixed text	<code>\$Tn↵</code>	Calling up Calling up fixed text (n = text number, one to four digits)	[2]
Entering variables	<code>\$VEcc...↵</code>	Entering variables from the current insertion position	[3]
	<code>\$VPn↵</code>	Selecting insertion position of variables (n = running number of variables, 0 – 255)	[4]
Deleting text	<code>\$E↵</code>	Clearing text in the display	[5]

---

**Commands for text formatting**

Line break	<b>\$C</b>	Forced line break	[6]
Flashing of individual characters	<b>\$F1</b>	Flashing of following characters on	[7]
	<b>\$F0</b>	Flashing of following characters off	[8]
Marquee text	<b>\$Y</b>	Marquee text from current position until end of text or \$C	[9]
Charater set	<b>\$M1</b>	Character set Acala 7	[10]
	<b>\$M2</b>	Character set Acala 7 extended	[11]
	<b>\$M3</b>	Not applicable	[12]
	<b>\$M4</b>	Not applicable	[13]
	<b>\$M5</b>	User-defined character set	[14]
	<b>\$M6</b>	Not applicable	[15]
LED color	<b>\$A0</b>	Red	[16]
	<b>\$A1</b>	Green	[17]
	<b>\$A2</b>	Orange	[18]
Place holder for variables	<b>\$VS</b>	Inserting place holders for variables	[19]
Inserting time	<b>\$HA</b>	Current time(HH:MM:SS)	[20]
	<b>\$HH</b>	Hour of current time (HH)	[21]
	<b>\$HM</b>	Minute of current time (MM)	[22]
	<b>\$HS</b>	Second of current time (SS)	[23]
Inserting date	<b>\$DA</b>	Current date, 4-digit year (TT.MM.JJJJ)	[24]
	<b>\$DB</b>	Current date, 2-digit year (TT.MM.JJ)	[25]
	<b>\$DD</b>	Current day (TT)	[26]
	<b>\$DM</b>	Current month (MM)	[27]
	<b>\$DY</b>	Current year, 4-digits (JJJJ)	[28]
	<b>\$DZ</b>	Current year, 2-digits (JJ)	[29]
	<b>\$DW</b>	Weekday in selected dialog language	[30]
Bar graph	<b>\$Gnnnn</b>	Bar graph display (nnnn = number of columns)	[31]
\$ character	<b>\$ \$</b>	Display of the '\$' character in the text	[32]

**Commands for display options**

Flashing	<b>\$F1↵</b>	Flashing of the entire display on	[33]
	<b>↵F0</b>	Flashing of the entire display off	[34]
Brightness	<b>\$B0↵</b>	Normal	[35]
	<b>\$B1↵</b>	Reduced	[36]
	<b>\$B2↵</b>	Blanking of the display	[37]
Reset	<b>\$0↵</b>	Restarting the display	[38]

#### Commands for loading and reading back

Time/date	<code>\$SHhmmss↓</code>	Setting time	[39]
time/date	<code>\$SDmddy↓</code>	Setting date	[40]
	<code>\$SWx↓</code>	Weekday (x: 1 = Mo, 2 = Tu, 3 = We etc. until 7 = Su)	[41]
Time/date	<code>\$RH↓</code>	Exporting the time via the Ethernet interface	[42]
time/date	<code>\$RD↓</code>	Exporting the day of the week and the date via the Ethernet interface	[43]

Online texts Dynamic texts are transmitted to the display as data telegrams [1]. Any text found in the display is cleared when an online text is received.

Static texts Static texts are called up using the command `$Tn↓` [2]. *n* is the text number; it can be from one to four digits. Any text in the display is cleared when a fixed text is called up.

Initial text Once the operating voltage has been applied, an LED dot in the upper left-hand corner of the display illuminates to indicate that the unit is ready for operation. If an initial text is to appear in the display instead (e.g. 'System operational'), this text is to be saved in the text memory with text number 0, and displaying of the initial text is to be set in menu item 20 (see Chapter 5).

Inserting variables This operating mode is used when the units are to display so-called text masks, in which only certain characters are changed, e.g. for the updating of numerical values as in the following:

**Temp. 172 °C**

The text parts *Temp.* and °C are fixed and do not change. The numbers, on the other hand, are continually updated variable text components.

In principle, updating could occur with online texts containing both the fixed and the variable text components. The data transfer required here is considerable, however.

The SX602 series offers the advantageous alternative of a one-time transmission of the fixed text components to the display and subsequent insertion of just the appropriate characters (variables) to update the variable text components. In the example, the fixed text parts *Temp.* and °C are displayed by means of the following data telegram.

`$M1Temp. $VS$VS$VS °C$↓`

The place holders for variables to be inserted later are marked with `$VS` [19]. They first appear blank in the display. A variable corresponds to a character to be displayed. Up to 256 variables can be inserted into a text.

The place holder from which the variables are to be inserted in the text (insertion position) is marked with the `$VPn↓` command [4]. *n* is the running number of variables; it can be from one to three digits (0 – 255). In the example, the first insertion position is marked with the `$VP0↓` command.

Insertion of the variables in the place holders occurs with the `$VEcc...↓` command [3]. *cc...* stands for any characters. In the example, the variables are inserted with the data telegram `$VE172↓`.

In the example, the fixed text components were shown in the display as online text. Alternatively, they can be prepared as a fixed text called up from the text memory. The place holders for the variables are also to be marked with **\$VS** in the fixed text.

Deleting text	Any text in the display is cleared with the <b>\$E↓</b> command [5]. An LED dot then illuminates in the upper left-hand corner of the display.
Forced line break	If the text contains more characters than can be displayed in one line, a line break is inserted automatically at the end of the line, and the text is continued in the next line. A line break can also be forced at a certain place in the text, for example for correct hyphenation [6] using the command <b>\$c</b> .
Flashing	<p>Including <b>\$F1</b> in the data string causes the following characters to flash [7]. As soon as <b>\$F0</b> appears in the data string, the following characters are displayed statically [8].</p> <p>Flashing of the entire display can be activated with the <b>\$F1↓</b> command [33] and deactivated with the <b>\$F0↓</b> command [34].</p> <p>Flashing of the entire display can also be activated with a high signal level at function input F2. The function input has priority over the commands.</p>
Marquee text	Marquee text display is activated from the current position in the text with the <b>\$x</b> command [9]. It remains active up to the end of the text or a forced line break ( <b>\$C</b> ).
Character set	<p>The texts are displayed with the character set specified in menu item 22 as default (see Chapter 5). For loading another character set, one of the commands <b>\$M1</b>, <b>\$M2</b> or <b>\$M5</b> must be contained in the text [10, 11, 14].</p> <p>The commands <b>\$M1</b> and <b>\$M2</b> load the permanently installed character sets Acala 7 [10] and Acala 7 extended [11].</p> <p>A user-defined character set [14] can be loaded with the command <b>\$M5</b>. The Acala 7 P character set is preinstalled here. It can be replaced by a character set created by the user, for example.</p> <p>The commands <b>\$M3</b> [12], <b>\$M4</b> [13] and <b>\$M6</b> [15] must not be used.</p> <p>The optional character sets and a tool for generating user-defined character sets are included on a data medium. The tool is also used to install character sets, to save character sets to data media and to read back installed character sets.</p>
LED color	Devices with switchable LED color (see chapter 3) display the texts in red by default. For a color change, the command <b>\$A0</b> (red), <b>\$A1</b> (green) or <b>\$A2</b> (orange) must be contained in the text [16...18].
Inserting time/date	<p>The units have a real-time clock with a date and weekday display. The current time, date or parts of them can be inserted into the text with the <b>\$H...</b> and <b>\$D...</b> commands [20 – 30]. The year can be displayed with four [24, 28] or two [25, 29] digits.</p> <p>The day of the week is displayed abbreviated to two letters in the language set in menu item 23 (see Chapter 5).</p>

Bar graph	<p>The <b>\$Gnnnn</b> command activates the bar graph display [31]. <b>nnnn</b> stands for the number of illuminating columns, i.e. the length of the bar graph and must always be four digits.</p> <p>The illuminating color of the bar graph can only be red or green. The <b>\$A2</b> command for the color orange [18] is ignored in bar graph mode].</p>
\$ character	<p>The command for displaying the '\$' character is <b>\$\$</b> [32].</p>
Brightness	<p>The brightness of the display can be reduced with the <b>\$B1↓</b> command [36] and reset to the normal brightness with the <b>\$B0↓</b> command [35].</p> <p>The brightness can also be reduced with a high signal level on function input F1. The function input has priority over the control commands.</p>
Blanking	<p>Blanking of the display can be activated with the <b>\$B2↓</b> command [37] and deactivated with the <b>\$B0↓</b> or <b>\$B1↓</b> commands [35, 36]. The text in the display is not cleared here.</p>
Reset	<p>The <b>\$0↓</b> command restarts the unit [38].</p>
Setting time/date	<p>Setting of the time occurs with the <b>\$SHhmmss↓</b> command [39]. <b>hh</b> stands for hours (24-hour format), <b>mm</b> for minutes and <b>ss</b> for seconds (e.g. <b>\$SH204515↓</b> = 20:45:15 Uhr).</p> <p>Setting of the date occurs with the <b>\$SDddmmyy↓</b> command [43]. <b>dd</b> stands for the day, <b>mm</b> for the month and <b>yy</b> for the year (e.g. <b>\$SD200804↓</b> = 20.08.2004).</p> <p>Setting of the weekday occurs with the <b>\$SWx↓</b> command [41]. <b>x</b> stands for the respective weekday: 1 = Monday, 2 = Tuesday, 3 = Wednesday, 4 = Thursday, 5 = Friday, 6 = Saturday and 7 = Sunday. The day of the week is displayed abbreviated to two letters in the language set in menu item 23 (see Chapter 5).</p> <p>The time, date and weekday can also be set in menu items 90 – 95 (see Chapter 5).</p>
Reading out time/date	<p>The current time can be read out via the interface with the <b>\$RH↓</b> command [45], and the current date, including the weekday, with the <b>\$RD↓</b> command [46].</p>

## Menu display

The parameterization of the devices is carried out in a menu of the menu display. In normal operation, the status messages appear in the menu display (see chapter 2).

## Menu operation

To reach the menu, press both menu buttons simultaneously (approx. 1 sec.) until an audible signal is heard and menu item 01 appears in the menu display. Now, you can navigate in the menu as follows:

Next menu item:	Shortly press key [↕]
Page menu items forward:	Press key [↕] long
Previous menu item:	Double click on key [↕]
Page menu items backward:	Double click on [↕] and keep it pressed
Next setting	Shortly press key [↔]
Page settings forward:	Press key [↔] long
Previous setting	Double click on key [↔]
Page setting backward:	Double click on [↔] and keep it pressed

The menu ends in menu item 99 with the button [↕]. The settings made are either saved (set), not saved (escape) or the factory settings, except for menu item 01, are reset, depending on the setting selected in menu item 99.

Canceling the menu without saving the settings made is possible by pressing both menu buttons longer (approx. 1 sec.) or will occur automatically if 60 seconds pass without a menu button being pressed.

Once the menu is closed, the unit behaves in the same manner as when the operating voltage was applied.

An LED dot illuminates in the upper left-hand corner of the display in menu mode. Control of the display is not possible in menu mode.

## Menu table

The menu items are displayed in the following menu table. The factory settings are marked with an \*. Individual menu items or settings can be suppressed in another menu item, depending on the unit version or setting.

Menu item	Settings	Menu display
10 Time-out	No time-out *	10 0
	Time-out after 2 s	10 2
	Time-out after 4 s	10 4
	Time-out after 8 s	10 8
	Time-out after 16 s	10 16
	Time-out after 32 s	10 32
	Time-out after 64 s	10 64
	Time-out after 128 s	10 128
20 Initial text	Not displaying initial text*	20 0
	Displaying initial text	20 1
21 Paging interval	3 seconds *	21 3
	↓ 30 seconds *	↓ 21 30



Menu item		Settings	Menu display	
22	Standard character set	Acala 7*	22	7
		Acala 7 extended	22	7E
		Not applicable	22	14C
		Not applicable	22	14E
		User-defined character set	22	U1
		Not applicable	22	U2
23	Language	German*	23	G
		French	23	F
		English	23	E
24	Display test	No display test at power-on *	24	0
		Display test at power-on	24	1
IP	IP-Address	Static*	IP	5LRB
		DHCP	IP	DHCP
I1	IP-Address Byte 1 (xxx.- . . -)	0	1.1	0
		↓ 192*	↓	
		192.168.127.254*	1.1	255
I2	IP-Address Byte 2 (- - -.xxx.- - -)	0	1.2	0
		↓ 168*	↓	
		255	1.2	255
I3	IP-Address Byte 3 (- - - - -.xxx.- - -)	0	1.3	0
		↓ 127*	↓	
		255	1.3	255
I4	IP-Address Byte 4 (- - - - -.xxx)	1	1.4	1
		↓ 254*	↓	
		254	1.4	254
S1	Subnet Mask Byte 1 (xxx.- . . -)	0	5.1	0
		↓ 255*	↓	
		255.255.0.0*	5.1	255
S2	Subnet Mask Byte 2 (- - -.xxx.- - -)	0	5.2	0
		↓ 255*	↓	
		255	5.2	255
S3	Subnet Mask Byte 3 (- - - - -.xxx.- - -)	0	5.3	0
		↓ 000*	↓	
		255	5.3	255
S4	Subnet Mask Byte 4 (- - - - -.xxx)	1	5.4	1
		↓ 000*	↓	
		254	5.4	254

Menu item		Settings	Menu display	
G1	Standard-Gateway	0	<b>01</b>	<b>0</b>
	Byte 1 (xxx.-.-.-)	↓ 192*	↓	
	192.168.127.1*	255	<b>01</b>	<b>255</b>
G2	Standard-Gateway	0	<b>02</b>	<b>0</b>
	Byte 2 (-.-.xxx.-.-)	↓ 168*	↓	
		255	<b>02</b>	<b>255</b>
G3	Standard-Gateway	0	<b>03</b>	<b>0</b>
	Byte 3 (-.-.-.-.xxx.-.-)	↓ 127*	↓	
		255	<b>03</b>	<b>255</b>
G4	Standard-Gateway	1	<b>04</b>	<b>1</b>
	Byte 4 (-.-.-.-.xxx)	↓ 001*	↓	
		254	<b>04</b>	<b>254</b>
90	Setting date (year)	05	<b>90</b>	<b>05</b>
		↓	↓	
		99	<b>90</b>	<b>99</b>
91	Setting date (month)	1	<b>91</b>	<b>1</b>
		↓	↓	
		12	<b>91</b>	<b>12</b>
92	Setting date (day)	1	<b>92</b>	<b>1</b>
		↓	↓	
		31	<b>92</b>	<b>31</b>
93	Setting weekday	Monday	<b>93</b>	<b>1</b>
		Tuesday	<b>93</b>	<b>2</b>
		Wednesday	<b>93</b>	<b>3</b>
		Thursday	<b>93</b>	<b>4</b>
		Friday	<b>93</b>	<b>5</b>
		Saturday	<b>93</b>	<b>6</b>
		Sunday	<b>93</b>	<b>7</b>
94	Setting time (hours)	0	<b>94</b>	<b>0</b>
		↓	↓	
		23	<b>94</b>	<b>23</b>
95	Setting time (minutes)	0	<b>95</b>	<b>0</b>
		↓	↓	
		59	<b>95</b>	<b>59</b>
99	Saving	Saving parameters* (Set)	<b>99</b>	<b>SET</b>
		Not saving parameters (Escape)	<b>99</b>	<b>ESC</b>
		Resetting to the default settings (Default)	<b>99</b>	<b>DEF</b>

Time-out	<p>In menu item 10, it is possible to set whether a time-out occurs, and if so, after what time. Time-out means that the display is cleared if it has not received a data telegram after a defined time period. An LED dot then illuminates in the upper left-hand corner of the display.</p>
Initial text	<p>Once the operating voltage has been applied, an LED dot in the upper left-hand corner of the display illuminates to indicate that the unit is ready for operation. If an initial text is to appear in the display instead (e.g. 'System operational'), this text is to be stored in the text memory with text number 0, and displaying of the initial text is to be set in menu item 20.</p> <p>If a display test is preselected in menu item 24, it appears in the display before the initial text.</p>
Paging interval	<p>If a text contains more characters than can be shown in the display, it is automatically displayed in paging mode. The page change interval can be set between 3 and 30 seconds in menu item 21.</p>
Character set	<p>In menu item 22, you can set the default character set used to display the texts.</p> <p>The character sets Acala 7 and Acala 7 extended are permanently installed in the units.</p> <p>A user-defined character set can be loaded with the setting <i>U1</i>. The Acala 7 P character set is preinstalled here. It can be replaced by a character set created by the user, for example.</p> <p>The settings <i>I4C</i>, <i>I4E</i> and <i>U2</i> must not be used.</p> <p>The optional character sets and a tool for generating user-defined character sets are included on a data medium. The tool is also used to install character sets, to save character sets to data media and to read back installed character sets.</p>
Language	<p>In menu item 23, you can set the language in which the weekday is displayed (abbreviated to two letters).</p>
Display test	<p>In menu item 24, you can set whether a display test is to be performed after the operating voltage is applied.</p>
Network parameters	<p>The network parameters can be set in the menu and no external aids are necessary. Afterwards the units can be accessed via the network. Further settings can then be made via the network (see chapter 6).</p> <p>In the IP menu item, static address assignment or DHCP must be selected.</p> <p>In the I1...I4 menu items, the four bytes of the IP address are set, if static address assignment has been selected.</p> <p>In the G1...G4 menu items, the four bytes of the standard gateway address are set, if static address assignment has been selected.</p> <p>In the S1...S4 menu items, the four address bytes of the Subnet Mask are set, if static address assignment has been selected.</p>

Upon resetting the factory settings (Default) in menu item 99, the following network parameters are set:

- Static address assignment
- IP-Address 192.168.127.254
- Subnet Mask 255.255.000.000
- Standard-Gateway 192.168.127.001

#### Time/date

The year, month, day and weekday of the real-time clock are set in menu items 90 – 93. The time at which the clock is to be started is set in menu items 94 – 95. Then select menu item 99 and select the setting *SE* there. When the set time is reached, briefly press the left menu button [↕] the clock is now set to the current time.

If the settings in menu items 90 – 93 (date) and 94 – 95 (time) are not changed when the menu is run through, the current settings for the time, date and weekday are retained when the menu is exited. Therefore, the clock only needs to be set when running through the menu if this is intended.

Setting the clock can also occur with control commands via the Ethernet interface (see Chapter 4).

Attention: Setting unrealistic date values, e.g. 31/02/06 can lead to unpredictable date displays and is therefore impermissible.

---

**Chapter 6 Configuration**

---

MAC address	The MAC address of the unit is to be found on the Ethernet coupling of the control processor (see label). It is possibly needed for commissioning and should be written down on page 2 of this operating manual before the unit is mounted on a hardly accessible location.
Basic configuration	The basic configuration can be set up without external aids via the menu (see chapter 5). To integrate the unit in the network, either DHCP must be activated, or the static IP address, the relevant Subnet Mask and, if necessary, the IP address of the standard gateway must be set. These values are assigned by the system administrator and should be known before putting the unit into operation.
Configuration via network	As soon as the units can be accessed via TCP/IP, additional configuration can take place via Telnet and HTTP. Access can be password-protected or can be deactivated, to prevent unauthorized operations. As-delivered and after setting the default in menu item U, access is enabled.
Additional information	The configuration dialogs are self-explanatory. For detailed information, please refer to the documentation of the Ethernet coupling (Moxa NE4100T type). For further information and PC tools, please go to <a href="http://www.moxa.com">www.moxa.com</a> .
Basic setting	Via Telnet and HTTP the gateway can inadvertently be parameterized so that it is no longer accessible via the network. In this case the gateway can be reset in a defined status via menu and selection of default in menu item U (see chapter 4) and after resetting of the network parameters it can be accessed via network again.

---

**Chapter 7 Status messages**

---

Fault messages                      Serious faults due to improper operation or faulty operating conditions are indicated in the display. The following messages are possible:

Fault message	Cause	Elimination
<b>No Text</b>	The text called up is not saved in the fixed text memory.	The text is to be loaded into the fixed text memory.
<b>Syntax Error</b>	A faulty command was sent to the display	The command must be corrected (see command table in chapter 6).

0	<NUL>	64	@	128	€	192	A
1	☺	65	A	129	ù	193	Б
2	<STX>	66	B	130	é	194	В
3	<ETX>	67	C	131	â	195	Г
4	<EOT>	68	D	132	ä	196	Д
5	♣	69	E	133	à	197	Е
6	<ACK>	70	F	134	á	198	Ж
7	<BEL>	71	G	135	ç	199	З
8	<BS>	72	H	136	ê	200	И
9	<HT>	73	I	137	ë	201	Й
10	<LF>	74	J	138	è	202	К
11	♂	75	K	139	ï	203	Л
12	♀	76	L	140	î	204	М
13	<CR>	77	M	141	í	205	Н
14	♫	78	N	142	ä	206	О
15	*	79	O	143	á	207	П
16	<DLE>	80	P	144	é	208	Р
17	<XON>	81	Q	145	æ	209	С
18	↕	82	R	146	æ	210	Т
19	<XOFF>	83	S	147	ô	211	У
20	¶	84	T	148	ó	212	Ф
21	<NAK>	85	U	149	ò	213	Х
22		86	V	150	û	214	Ц
23	↕	87	W	151	ù	215	Ч
24	↑	88	X	152	ÿ	216	Ш
25	↓	89	Y	153	ö	217	Щ
26	<EOF>	90	Z	154	ü	218	Ъ
27	<ESC>	91	[	155	ø	219	Ы
28		92	\	156	£	220	Ь
29	↔	93	]	157	ø	221	Э
30	▲	94	^	158	x	222	Ю
31	▼	95	_	159	f	223	Я
32	<SPACE>	96	`	160	á	224	
33	!	97	A	161	í	225	ss
34	"	98	B	162	ó	226	
35	#	99	C	163	ú	227	
36	\$	100	D	164	ñ	228	
37	%	101	E	165	ñ	229	
38	&	102	F	166	ª	230	
39	'	103	G	167	ρ	231	
40	(	104	H	168	reserved	232	
41	)	105	I	169		233	
42	*	106	J	170		234	
43	+	107	K	171		235	
44	,	108	L	172		236	
45	-	109	M	173		237	
46	.	110	N	174		238	
47	/	111	O	175		239	
48	0	112	P	176		240	
49	1	113	Q	177		241	
50	2	114	R	178		242	
51	3	115	S	179	reserved	243	
52	4	116	T	180	reserved	244	reserved
53	5	117	U	181	reserved	245	reserved
54	6	118	V	182	reserved	246	
55	7	119	W	183	reserved	247	
56	8	120	X	184	reserved	248	
57	9	121	Y	185	reserved	249	
58	:	122	Z	186	reserved	250	
59	;	123	{	187	Pt	251	
60	<	124		188		252	
61	=	125	}	189	¢	253	
62	>	126	~	190	¥	254	
63	?	127	△	191	ë	255	ρ

Unit properties

The model designation is structured as follows:

SX602	-	[ ] [ ]	/	[ ] [ ]	/	[ ] [ ]	-	[ ] [ ] [ ] [ ]	/	[ ] [ ]	-	[ ] [ ] [ ] [ ]
	:	:	:	:	:	:	:	:	:	:	:	:
4 characters		0 4	:	:	:	:	:	:	:	:	:	:
6 characters		0 6	:	:	:	:	:	:	:	:	:	:
8 characters		0 8	:	:	:	:	:	:	:	:	:	:
10 characters		1 0	:	:	:	:	:	:	:	:	:	:
12 characters		1 2	:	:	:	:	:	:	:	:	:	:
20 characters		2 0	:	:	:	:	:	:	:	:	:	:
40 characters		4 0	:	:	:	:	:	:	:	:	:	:
			:	:	:	:	:	:	:	:	:	:
Character height of 50 mm		0 5	:	:	:	:	:	:	:	:	:	:
Character height of 100 mm		1 0	:	:	:	:	:	:	:	:	:	:
Character height of 160 mm		1 6	:	:	:	:	:	:	:	:	:	:
Character height of 250 mm		2 5	:	:	:	:	:	:	:	:	:	:
			:	:	:	:	:	:	:	:	:	:
Standard LED		0	:	:	:	:	:	:	:	:	:	:
LED for outdoor use		2	:	:	:	:	:	:	:	:	:	:
			:	:	:	:	:	:	:	:	:	:
Red character color		R	:	:	:	:	:	:	:	:	:	:
Green character color		G	:	:	:	:	:	:	:	:	:	:
Switchable red/green/orange character color		M	:	:	:	:	:	:	:	:	:	:
			:	:	:	:	:	:	:	:	:	:
Display readable on one side		1	:	:	:	:	:	:	:	:	:	:
Display readable on both sides		2	:	:	:	:	:	:	:	:	:	:
			:	:	:	:	:	:	:	:	:	:
Steel sheet housing, coated		0	:	:	:	:	:	:	:	:	:	:
Steel sheet housing, bilayer painting		1	:	:	:	:	:	:	:	:	:	:
Steel sheet housing V2A, coated		2	:	:	:	:	:	:	:	:	:	:
Steel sheet housing V2A, brushed		3	:	:	:	:	:	:	:	:	:	:
Steel sheet housing V4A, brushed		4	:	:	:	:	:	:	:	:	:	:
			:	:	:	:	:	:	:	:	:	:
Protection type IP54		0	:	:	:	:	:	:	:	:	:	:
Protection type IP65		1	:	:	:	:	:	:	:	:	:	:
Protection type IP54 climate adjustment		2	:	:	:	:	:	:	:	:	:	:
Protection type IP54 climate adjustment and heating		4	:	:	:	:	:	:	:	:	:	:
			:	:	:	:	:	:	:	:	:	:
Wall mounting, cable entry point from the bottom		0	:	:	:	:	:	:	:	:	:	:
Wall mounting, cable entry point from the top		1	:	:	:	:	:	:	:	:	:	:
Hanging installation, cable entry point from the bottom		2	:	:	:	:	:	:	:	:	:	:
Hanging installation, cable entry point from the top		3	:	:	:	:	:	:	:	:	:	:
Wall and hanging installation, cable entry point from the bottom		4	:	:	:	:	:	:	:	:	:	:
Wall and hanging installation, cable entry point from the top		5	:	:	:	:	:	:	:	:	:	:
			:	:	:	:	:	:	:	:	:	:
Power supply 230 V AC ±15 %, 50 Hz			:	:	:	:	:	:	:	:	:	A
Power supply 115 V AC ±15 %, 60 Hz			:	:	:	:	:	:	:	:	:	C

Housing colors

Front pane: RAL 7035 light grey  
RAL 5002 ultramarine

Front frame

SX602-xxx/xx/xR-xxx/xx-xx: plastic, tinted red, non-reflective  
SX602-xxx/xx/xM-xxx/xx-xx: plastic, clear, non-reflective

Ambient conditions

Operating temperature: 0...40 °C  
Storage temperature: -30...85 °C  
Relative humidity: max. 95 % (non-condensing)

## Max. power consumption

### Units with character height of 50 mm

#### One-sided display

SX602-20/05/0R-1xx/xx-xx	approx. 45 VA
SX602-20/05/0M-1xx/xx-xx	approx. 85 VA
SX602-40/05/0R-1xx/xx-xx	approx. 75 VA
SX602-40/05/0M-1xx/xx-xx	approx. 130 VA

#### Double-sided display

SX602-20/05/0R-2xx/xx-xx	approx. 85 VA
SX602-20/05/0M-2xx/xx-xx	approx. 165 VA
SX602-40/05/0R-2xx/xx-xx	approx. 170 VA
SX602-40/05/0M-2xx/xx-xx	approx. 320 VA

### Units with character height of 100 mm

#### One-sided display

SX602-10/10/0R-1xx/xx-xx	approx. 40 VA
SX602-10/10/0G-1xx/xx-xx	approx. 40 VA
SX602-20/10/0R-1xx/xx-xx	approx. 75 VA
SX602-20/10/0G-1xx/xx-xx	approx. 75 VA

#### Double-sided display

SX602-10/10/0R-2xx/xx-xx	approx. 75 VA
SX602-10/10/0G-2xx/xx-xx	approx. 75 VA
SX602-20/10/0R-2xx/xx-xx	approx. 150 VA
SX602-20/10/0G-2xx/xx-xx	approx. 150 VA

### Units with character height of 160 mm

#### One-sided display

SX602-04/16/0R-1xx/xx-xx	approx. 45 VA
SX602-04/16/0G-1xx/xx-xx	approx. 45 VA
SX602-06/16/0R-1xx/xx-xx	approx. 60 VA
SX602-06/16/0G-1xx/xx-xx	approx. 60 VA
SX602-08/16/0R-1xx/xx-xx	approx. 80 VA
SX602-08/16/0G-1xx/xx-xx	approx. 80 VA
SX602-10/16/0R-1xx/xx-xx	approx. 95 VA
SX602-10/16/0G-1xx/xx-xx	approx. 95 VA
SX602-12/16/0R-1xx/xx-xx	approx. 110 VA
SX602-12/16/0G-1xx/xx-xx	approx. 110 VA

#### Double-sided display

SX602-04/16/0R-2xx/xx-xx	approx. 80 VA
SX602-04/16/0G-2xx/xx-xx	approx. 80 VA
SX602-06/16/0R-2xx/xx-xx	approx. 115 VA
SX602-06/16/0G-2xx/xx-xx	approx. 115 VA
SX602-08/16/0R-2xx/xx-xx	approx. 150 VA
SX602-08/16/0G-2xx/xx-xx	approx. 150 VA
SX602-10/16/0R-2xx/xx-xx	approx. 180 VA
SX602-10/16/0G-2xx/xx-xx	approx. 180 VA
SX602-12/16/0R-2xx/xx-xx	approx. 215 VA
SX602-12/16/0G-2xx/xx-xx	approx. 215 VA

### Units with character height of 250 mm

#### One-sided display

SX602-04/25/0R-1xx/xx-xx	approx. 90 VA
SX602-04/25/0M-1xx/xx-xx	approx. 140 VA
SX602-06/25/0R-1xx/xx-xx	approx. 135 VA
SX602-06/25/0M-1xx/xx-xx	approx. 205 VA
SX602-08/25/0R-1xx/xx-xx	approx. 180 VA
SX602-08/25/0M-1xx/xx-xx	approx. 270 VA

#### Double-sided display

SX602-04/25/0R-2xx/xx-xx	approx. 170 VA
SX602-04/25/0M-2xx/xx-xx	approx. 270 VA
SX602-06/25/0R-2xx/xx-xx	approx. 260 VA
SX602-06/25/0M-2xx/xx-xx	approx. 400 VA
SX602-08/25/0R-2xx/xx-xx	approx. 350 VA
SX602-08/25/0M-2xx/xx-xx	approx. 530 VA

The power consumption of the device versions SX602-xx/xx/0R-xxx/xx-xx also applies for the following device versions:

SX602-xx/xx/0G-xxx/xx-xx	LED green
SX602-xx/xx/2x-xxx/xx-xx	LEDs for outdoor application

For units with built-in heating, the values for power consumption specified in the table increase by approx. 10 – 200 VA (exact values on request), depending on the unit size).

## Fixed text memory

Capacity:	128 KBytes
Number of texts:	max. 10.000
Length of texts:	max. 2048 characters

## Real-time clock

Precision:	20 ppm
------------	--------



Units with one-side display and character height of 50 and 100 mm

The following figure shows unit version SX602-20/05/0x-1xx/xx-xx, representing the other unit versions listed in the following table. All dimensions are in mm.

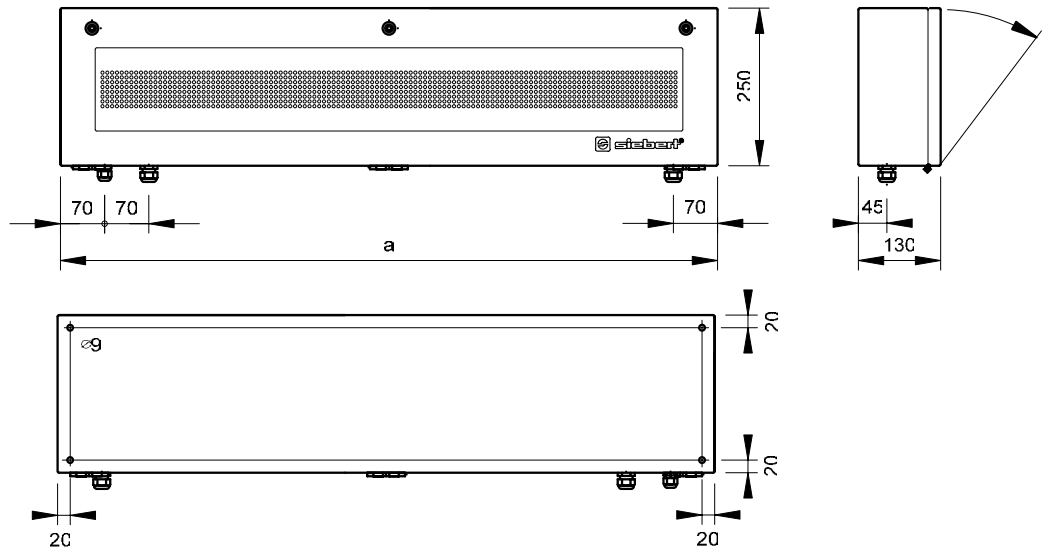

Unit version	a	Weight
SX602-20/05/0x-1xx/xx-xx	1040	approx. 16 kg
SX602-40/05/0x-1xx/xx-xx	1960	approx. 27 kg
SX602-10/10/0x-1xx/xx-xx	1040	approx. 16 kg
SX602-20/10/0x-1xx/xx-xx	1960	approx. 27 kg

Units with double-sided display and character height of 50 and 100 mm

The following figure shows unit version SX602-20/05/0x-2xx/xx-xx, representing the other unit versions listed in the following table. All dimensions are in mm.

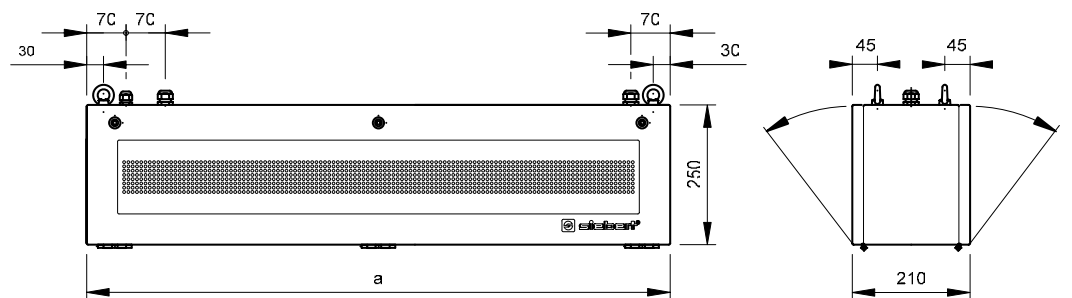

Unit version	a	Weight
SX602-20/05/0x-2xx/xx-xx	1040	approx. 16 kg
SX602-40/05/0x-2xx/xx-xx	1960	approx. 27 kg
SX602-10/10/0x-2xx/xx-xx	1040	approx. 16 kg
SX602-20/10/0x-2xx/xx-xx	1960	approx. 27 kg

Units with one-side display and character height of 100 and 250 mm

The following figure shows unit version SX602-06/16/0x-1xx/xx-xx, representing the other unit versions listed in the following table. All dimensions are in mm.

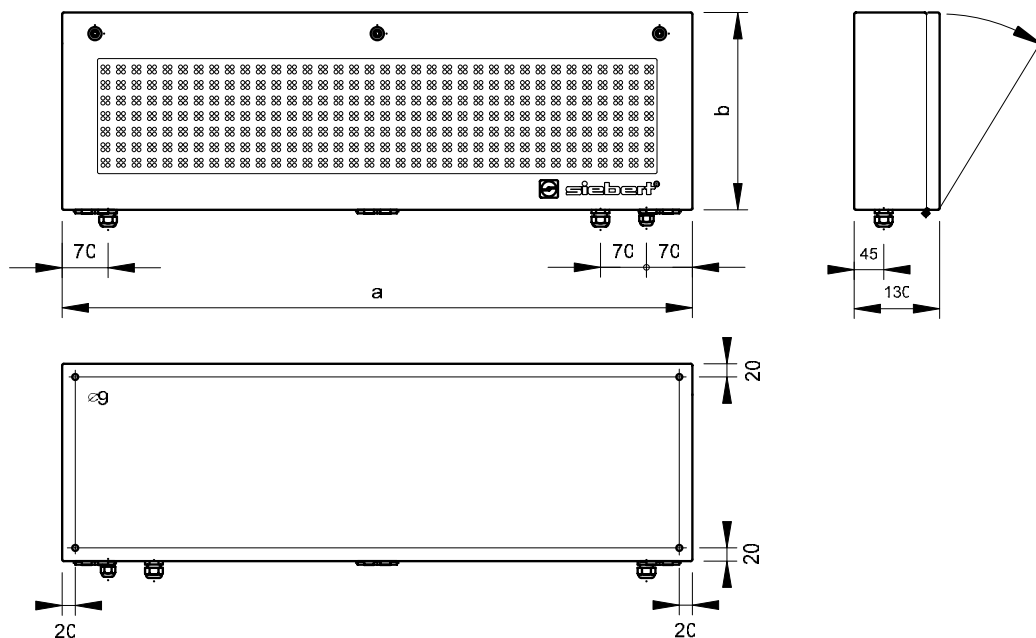

Unit version	a	b	Weight
SX602-04/16/0x-1xx/xx-xx	670	300	approx. 13 kg
SX602-06/16/0x-1xx/xx-xx	960	300	approx. 18 kg
SX602-08/16/0x-1xx/xx-xx	1240	300	approx. 22 kg
SX602-10/16/0x-1xx/xx-xx	1520	300	approx. 26 kg
SX602-12/16/0x-1xx/xx-xx	1810	300	approx. 30 kg
SX602-04/25/0x-1xx/xx-xx	1030	400	approx. 23 kg
SX602-06/25/0x-1xx/xx-xx	1500	400	approx. 32 kg
SX602-08/25/0x-1xx/xx-xx	1960	400	approx. 40 kg

Units with double-sided display and character height of 100 and 250 mm

The following figure shows unit version SX602-06/16/0x-2xx/xx-xx, representing the other unit versions listed in the following table. All dimensions are in mm.

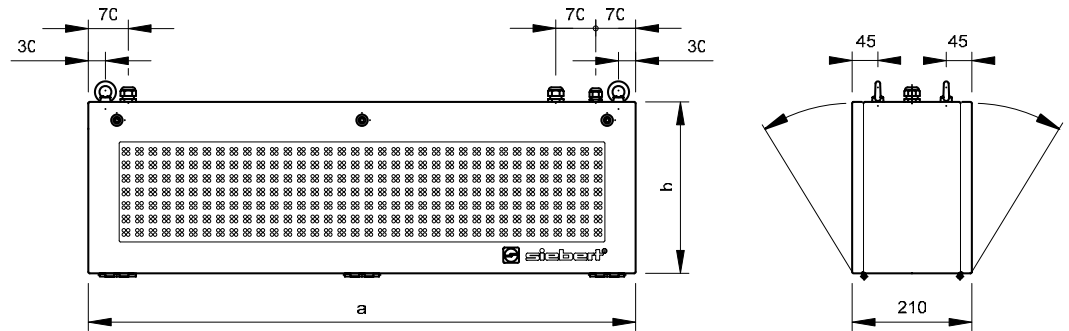

Unit version	a	b	Weight
SX602-04/16/0x-2xx/xx-xx	670	300	approx. 22 kg
SX602-06/16/0x-2xx/xx-xx	960	300	approx. 28 kg
SX602-08/16/0x-2xx/xx-xx	1240	300	approx. 34 kg
SX602-10/16/0x-2xx/xx-xx	1520	300	approx. 40 kg
SX602-12/16/0x-2xx/xx-xx	1810	300	approx. 46 kg
SX602-04/25/0x-2xx/xx-xx	1030	400	approx. 36 kg
SX602-06/25/0x-2xx/xx-xx	1500	400	approx. 48 kg
SX602-08/25/0x-2xx/xx-xx	1960	400	approx. 60 kg

