

## Series XC420

Digital displays for the photovoltaic  
Operating instructions

---

**Table of contents**

---

<b>1</b>	<b>Safety instructions</b>	<b>4</b>
	Important information .....	4
	Warning notice.....	4
	Intended use.....	4
	Special safety precautions for installation .....	4
	Qualified staff.....	5
	Grounding.....	5
	Mounting and installation.....	6
	Transport .....	6
	Disposal.....	6
	<b>Batteries and rechargeable batteries .....</b>	<b>6</b>
<b>2</b>	<b>Important information</b>	<b>7</b>
	Copyright .....	7
	Disclaimer.....	7
	Liability.....	7
	Cleaning .....	7
	Accuracy of the display .....	7
<b>3</b>	<b>Important start-up instructions</b>	<b>8</b>
<b>4</b>	<b>Product description</b>	<b>9</b>
	Brightness control.....	10
<b>5</b>	<b>Installation</b>	<b>11</b>
	Requirements to the installation site .....	11
	Installation material .....	11
	Opening the unit .....	11
	Mounting the unit.....	12
	Power supply connection .....	13
	Connection of the Ethernet cable .....	14
<b>6</b>	<b>Data source connection</b>	<b>15</b>
	Power meter/inverter/data logger with S0 interface .....	15
	Inverter/data logger with RS485 interface.....	16
	Connection of the Ethernet cable .....	17
<b>7</b>	<b>Start-up and configuration</b>	<b>18</b>
	Displays with USB interface (XC4xx-xxx-x-03) .....	18
	Displays with Ethernet interface (XC4-xx-xxx-x-05).....	18
	Configuration of the display.....	19
	Start-up and test.....	19
	Controls .....	19

<b>8 To close the display</b>	<b>20</b>
Closing the display for indoor use .....	20
Closing the display for outdoor use .....	20
<b>9 Technical data</b>	<b>21</b>
<b>10 SolarDisplayConfigurator</b>	<b>22</b>
Installation .....	22
System requirements .....	22
Starting the installation .....	22
Deinstallation .....	23
Configuration of the display .....	24
Connecting the display .....	24
Control concept .....	24
Configuration mode .....	25
Daughter displays .....	26
Interface .....	28
Selection of display or gateway .....	29
Selection of the display with USB or Bluetooth connection .....	29
Selection of the display or the gateway with Ethernet connection .....	30
Network set-up .....	31
S0 parameter .....	32
Select inverter .....	33
Set the inverter .....	34
Server settings of the display .....	35
Define the display .....	36
General settings .....	37
Power saving mode .....	38
Brightness .....	39
Configuration file .....	40
Inverter Interface Gateway .....	40
Complete configuration .....	41
Bluetooth connection .....	42
Installation .....	42
Coupling via Windows 10 .....	42
Bug fixing .....	46
<b>11 Service and Support</b>	<b>47</b>

## 1 Safety instructions

### Important information

Read these operating instructions before starting the unit. They provide you with important information on the use, safety and maintenance of the units. This helps you to protect yourself and prevent damage to the unit.

During the lifetime of the unit keep the operating instructions in an accessible place at all times. Hand over the operating instructions to any future owner of the unit. It is to be considered as part of the product.

The manufacturer is not liable if the information in these operating instructions are not complied with.

### Warning notice

Information intended to help you to avoid death, bodily harm or considerable damage to property is highlighted by the warning triangle shown here; it is imperative that this information be properly heeded.



#### **DANGER!**

Disregarding this warning notice leads to death or serious bodily harm.



#### **DANGER!**

Disregarding the warning notice can lead to death or serious bodily harm.



#### **DANGER!**

Disregarding the warning notice can lead to minor physical injuries or property damage.

### Intended use

The unit is intended for use in photovoltaic systems. It may only be operated within the limit values stipulated by the technical data.

During configuring, installing, testing, commissioning and maintenance of the unit, the applicable standards and safety regulations have to be observed.

Trouble-free, safety operation of the unit requires proper transport, storage, installation, mounting and careful operation and maintenance of the unit.

### Special safety precautions for installation



#### **CAUTION!**

Carefully seal the electrical equipment for safety reasons after commissioning.

Devices for indoor use have 16,5 mm wide connectors (upper figure):

Spread the connectors a bit to ensure a firm connection between the profiles. Check that the connectors are pressed so tightly that extraction of the connectors without tools (lever) is not possible. The key to seal the unit is included in the mounting kit.

Devices for outdoor use have 25 mm wide connectors (lower figure):

The connectors must be secured with the enclosed screws.

Fig.1

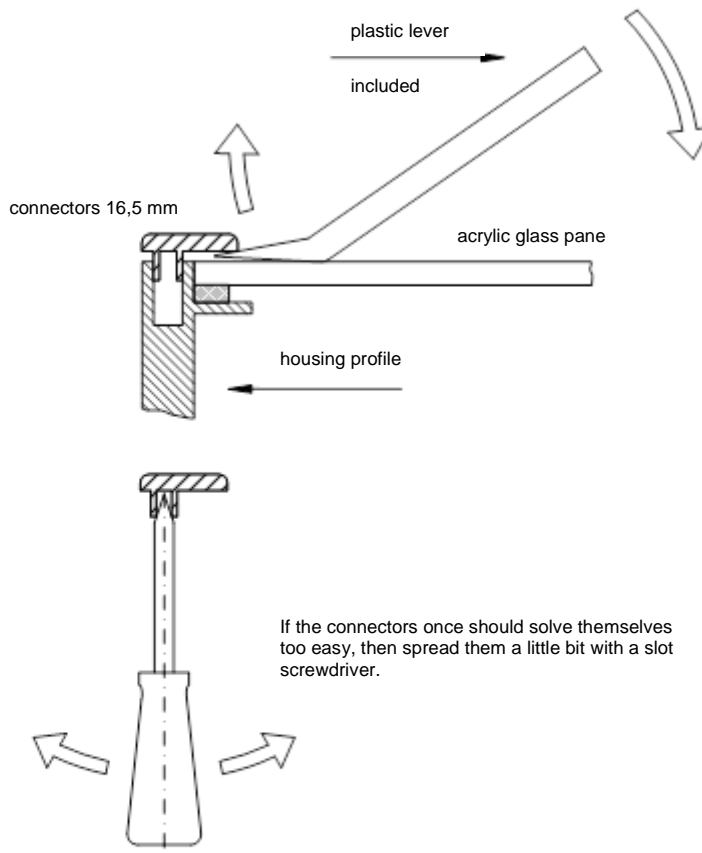
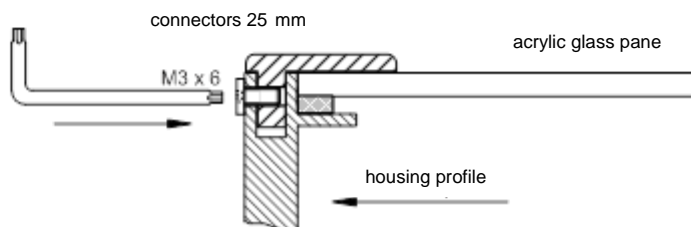

Fig. 2



### Qualified staff

The operating instructions are intended for trained professional electricians, familiar with the safety standards of electrical technology and industrial electronics.

Components inside the unit are voltage-carrying during operation. For this reason mounting and maintenance work may only be performed by professionally trained personnel while observing the corresponding safety regulations.

For safety reasons and due to the required compliance with the documented unit properties the repair and replacement of components and modules may only be carried out by the manufacturer or an authorized specialized company.

### Grounding

The unit is equipped with a metal housing. It complies with safety class I and requires a protective earth connection. The connecting cable for the operating voltage must contain a protective earth wire of a sufficient cross section (DIN VDE 0106 part 1, DIN VDE 0411 part 1).

The unit has no power switch. It is in operation immediately after applying operating voltage.

## Mounting and installation

The attachment options for the units were conceived in such a way as to ensure safe, reliable mounting. The user must ensure that the used fixing material guarantees, under the given surrounding conditions, a secure mounting.

When installing and commissioning please note the appropriate national and regional regulations.

## Transport

The unit must be transported clean and dry in the original packing. The transport temperature must be between  $-40\text{ °C}$  and  $+70\text{ °C}$ . Temperature fluctuations of more than  $20\text{ °C}$  per hour are non-permissible.

## Disposal

The unit is made of low-emission materials and is therefore recyclable. For an environmentally safe recycling contact a certified waste management enterprise. Units or parts which are no longer needed are to be disposed of in accordance with the regulations in effect in your country.

## Batteries and rechargeable batteries



As an end user you are legally obliged (battery regulation) to return all used batteries and rechargeable batteries! Disposal with household waste is prohibited.

Batteries containing harmful substances are marked with the following symbols, which indicate that disposal with household waste is prohibited. The designations for the decisive heavy metal are: Cd = cadmium, Hg = quicksilver, Pb = lead (the name appears on the battery/rechargeable battery, e.g. under the garbage can symbols shown on the left).



You can return your used batteries/rechargeable batteries to the collection points in your municipality or wherever batteries/rechargeable batteries are sold.

In doing so, you fulfil your legal obligations and make your contribution environmental protection.

---

## **2 Important information**

---

### **Copyright**

This documentation is protected by copyright. All rights are reserved.

No part of this documentation may be translated without written permission by Siebert Industrieelektronik GmbH. No part of this documentation may be reproduced in any form by print, photocopy or other methods, or processed by using electronic systems, duplicated or disseminated.

Siebert<sup>®</sup>, LRD<sup>®</sup> and XC-Board<sup>®</sup> are registered trade marks of Siebert Industrieelektronik GmbH. As far as other product names or company names are mentioned in this documentation they may be trade marks or trade names of their respective owners.

### **Disclaimer**

This documentation has been prepared with utmost care. For any mistakes we can not accept any liability. Corrections, improvement suggestions, criticism and suggestions are welcome. Please write to: [editing@siebert-solar.com](mailto:editing@siebert-solar.com)

### **Liability**

Availability and technical specifications of the product are subject to change. The data specified is indicated solely for product description. They are not intended to be guaranteed in a legal sense.

### **Cleaning**

For the care of the front panel use a scratch-free cloth. Do not push in the front pane during cleaning.

The unit must not be cleaned with a steam cleaner.

### **Accuracy of the display**

If the digital display is connected to a data output unit (inverter, data logger, etc.) via its data interface, RS485 or Ethernet it is purely an information output unit. It displays the data received via the data interface in readable digits. For the accuracy of information displayed, however, the data output unit is responsible. For problems or faulty display the data output unit has to be checked and to observe its operating instructions.

For problems or damages which are caused by changes of the data output unit (p. e. modified protocol structure, or modified product characteristics) no liability is assumed.

These operating instructions do not replace the operating instructions of the data output unit.

---

### 3 Important start-up instructions

---

During the commissioning of the display you need the following facilities for configuration:

- PC with the software Siebert 'SolarDisplayConfigurator'
- A suitable cable depending in the type of the display.

With displays of type ...-03 with USB interface the configuration is done via the integrated USB interface. A matching USB cable type C to USB type A is included in delivery.

With displays of type ...-05 with Ethernet interface the configuration is done via the Ethernet. Please have ready the following items:

- A cross-type Ethernet cable if you connect the PC for configuration directly with the display.
- A patch cable, if you connect the PC for configuration over a switch or router with the display.



## 4 Product description

The following figure shows the display in working condition.

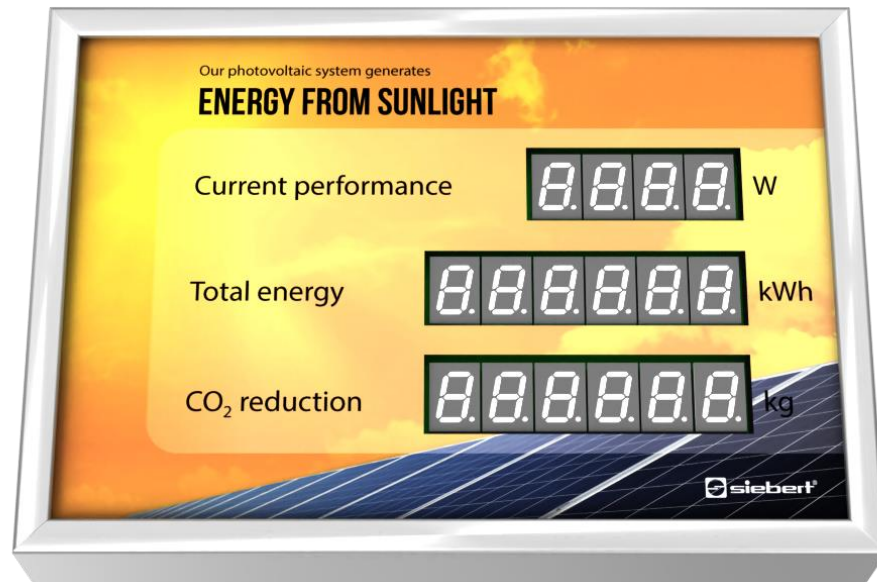

The display of series XC420 are available for indoor- and outdoor use.

Order number	Scope of application
XC420-xxx-N-xx	Displays for indoor use, protection type IP40
XC420-xxx-A-xx	Displays for outdoor use, protection type IP54

Units for outdoor use have screwed plug-in connectors, sealed cable feed-throughs with rubber lips and climate compensation elements.

The displays of the XC420 series are differed in the following interface versions:

Order number.	Interfaces
XC420-xxx-x-03	S0 PULSE, RS485 (screw-type terminals)
XC420-xxx-x-05	Ethernet (RJ45)

The scope of information consists of the following characteristic values, which you assign to the various fields corresponding to your front foil during the initial commissioning of your display:

- Current performance
- Total energy
- Daily energy
- CO2 saving is calculated with an adjustable factor from the total energy.

The display can calculate further core variables from the total energy via freely selectable factors. E.g. a conversion to the energy consumption of a typical household.

Furthermore, the following information can be displayed as required:

- Current time in HH:MM format
- Current date in DD.MM, DD.MM.YY or DD.MM.YYYY
- Air temperature and humidity with additional sensor

## **Brightness control**

The brightness of the LEDs can be manually adjusted to the ambient brightness.

Alternatively, the automatic brightness control can be activated with the 'SolarDisplayConfigurator'. The display automatically adjusts its luminosity to the ambient brightness. If the ambient brightness is lower, for example in cloudy sky or at night, the display dims down automatically to e.g. avoid glare effects. At high ambient brightness the display increases its brightness for better readability.

## 5 Installation

### Requirements to the installation site

The display is designed for wall mounting. The wall surface has to be plane and free of irregularities. The wall must have a sufficient capacity.

### Installation material

The installation material shown below is included in delivery:

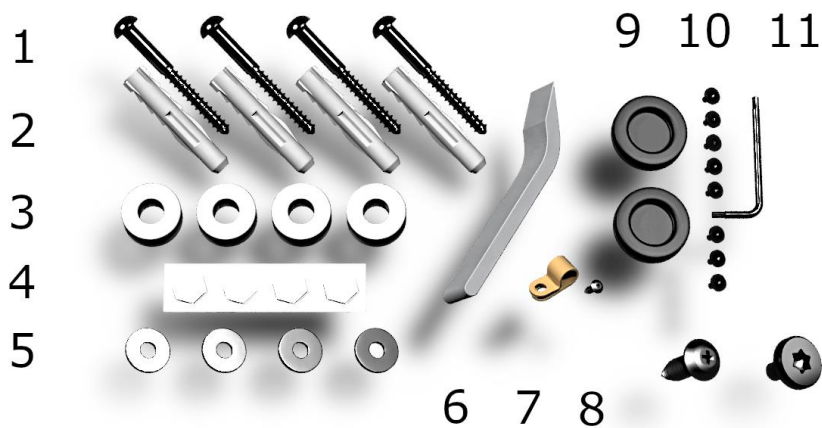

- 1 Screws for wall mounting
- 2 Dowels for wall mounting
- 3 Spacers for wall mounting
- 4 Self-adhesive strips to hold the spacers
- 5 Washers
- 6 Lever tools
- 7 Grounding clamp
- 8 Sheet-metal screw for grounding clamp
- 9\* Cable grommet seals
- 10\* Torx screw
- 11\* Torx screwdriver

\* only devices for outdoor use

Keep the lever tools and the screwdriver.

### Opening the unit

To open the unit you have to remove the connectors and to lift the front pane carefully.

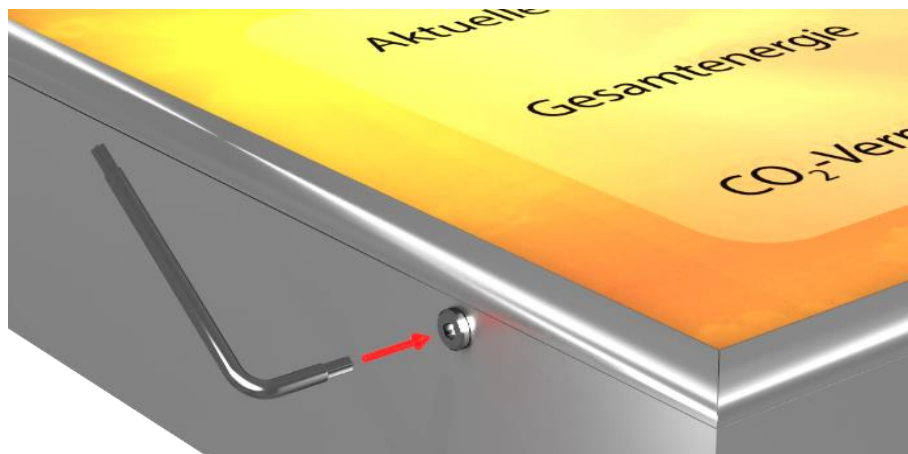

The connectors on devices for outdoor use are secured with torx screws all around against unintentional opening. For installation and disassembly a fitting torx wrench is included.



To open the device remove the torx screws and keep them carefully for later assembly.



Open the device by using the lever tool. First remove the connectors and then the front pane. Upon delivery, the connectors are only applied loosely.

### Mounting the unit

Mount the unit using the mounting holes with screws and dowels on the wall.

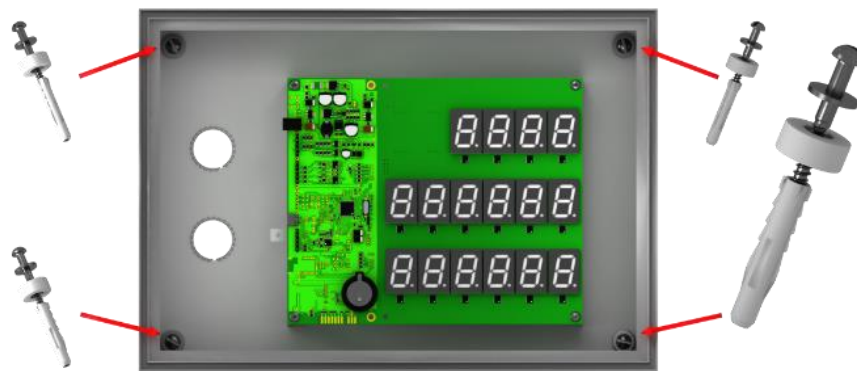

Use according proper mounting material if the screws and dowels included do not match.

The spacers, in combination with the screws, allow a fastening of the device with a distance of approximately 10 mm to the wall.



The cables can then be fed between wall and device (surface mounting). To fix the spacers during installation use the included hexagonal self-adhesive stripes.

### Power supply connection

After mounting the device on the wall you connect the line for the power supply to the terminal. Make sure that the 230V line was damaged nowhere during insertion into the device.

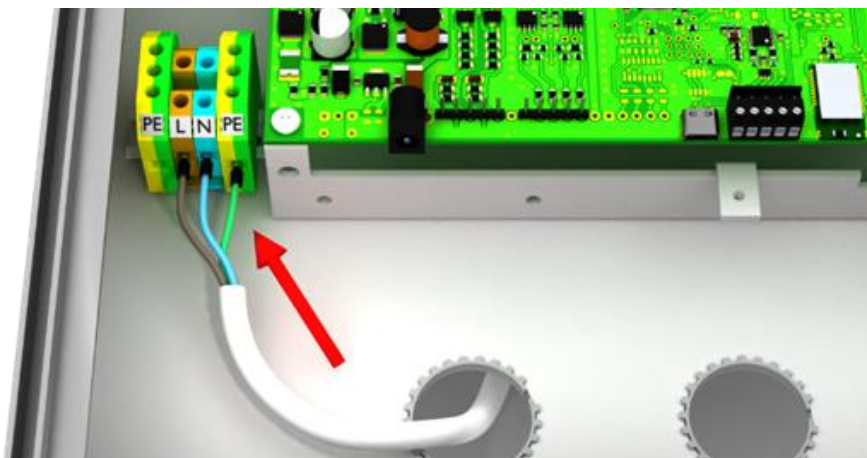

The unit has a metal housing. It corresponds with protection type I and needs a protective conductor connection. The connecting cable for the power supply must contain a protective ground wire connection with sufficient cross-section (DIN VDE 0106 Teil 1, DIN VDE 0411 part 1).

The protective ground wire (yellow/green) can be connected either to the yellow or the green terminal.

When first powered on numbers appear on all digits. Depending on the unit version, during later power-up – after implementing of the configuration – the decimal points light up.

## Connection of the Ethernet cable

Only valid for displays with Ethernet interface (XC4xx-xxx-x-05).

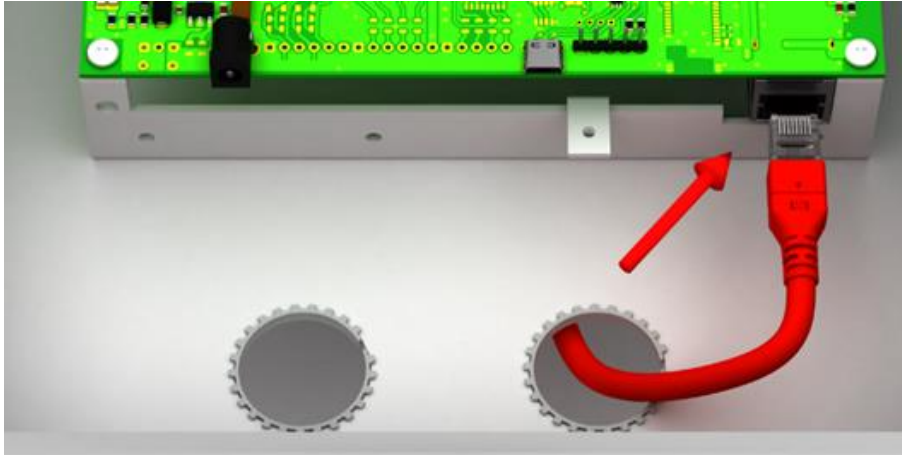

Displays with Ethernet interface are connected with an Ethernet cable cat. 5 or higher. Modern PCs or laptops recognize the cable type automatically.

If your display is operated with older network components, the following cables are required:

- a crosses Ethernet cable cat. 5 or higher for a direct connection to the PC or laptop with the display
- an Ethernet patch cable cat. 5 for the connection of the PC or laptop via a network switch or - hub with the display

## 6 Data source connection



The digital display is purely an information output device. It converts the sent data from the inverter/data logger/power meter into visual information but does not define the content of the numerical information.

### Power meter/inverter/data logger with S0 interface

Each power meter, data logger or inverter with impulse interface according to IEC/EN 62053-31 or DIN 43864 is suitable for the use with the large size displays.

The connection of the counter is at the designated S0- und S0+ terminals.

As connecting cable type J-Y(St)-Y, 2 x 0,6 mm<sup>2</sup> or similar is used. The maximum length is 200 meters.

When connecting pay attention to the correct polarity of the two signals.

Clamp the shield of the data line with the grounding clamp.

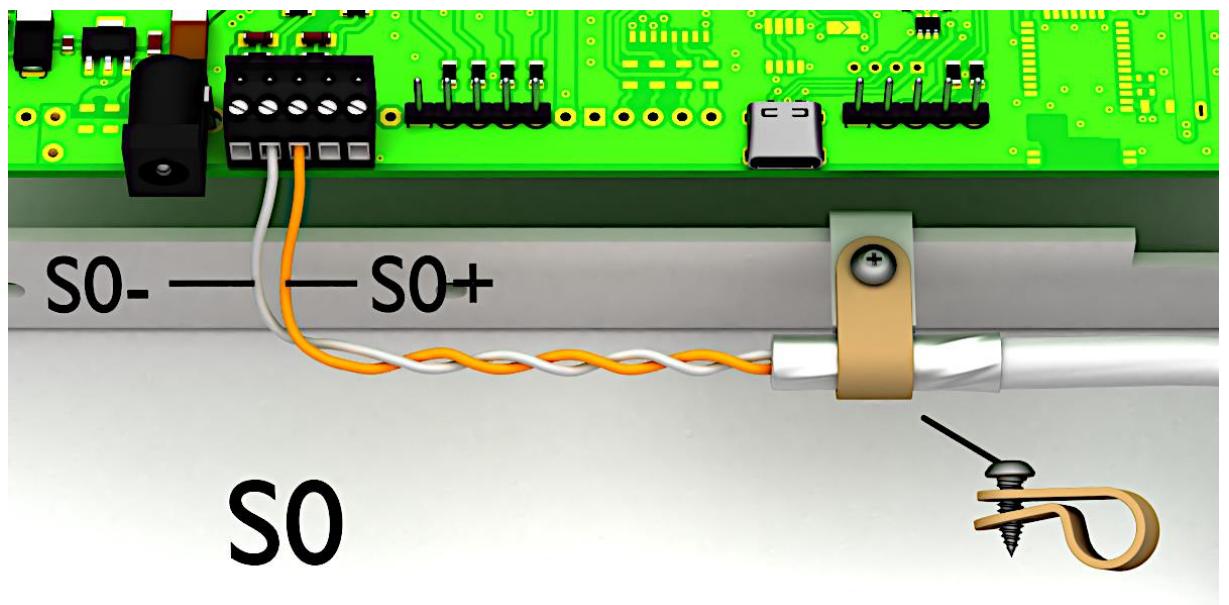

The picture shows a schematic representation

To configure the device via the USB interface an additional connection via the USB connection is required. After the configuration has been done this connection is no longer needed.

Continue chapter 'Start-up and configuration'.

### Inverter/data logger with RS485 interface

The connection of the inverter/data logger is at the point marked RS485 terminal as shown below.

As connecting cable type J-Y(St)-Y, 2 x 2 x 0,6 mm<sup>2</sup> or similar is used. The maximum length are 1.000 meters.

1. Connect RX+ of the display with TX+ of the data logger/inverter.
2. Connect RX- of the display with TX- of the data logger/inverter. For this use a twisted pair of conductors.
3. Connect the GND of the display with the GND of the data logger/inverter. The last wire in the cable is not needed. Cut this last wire off or use it as an additional GND wire.

Between RX+ and RX- a 120  $\Omega$  terminating resistor is installed.

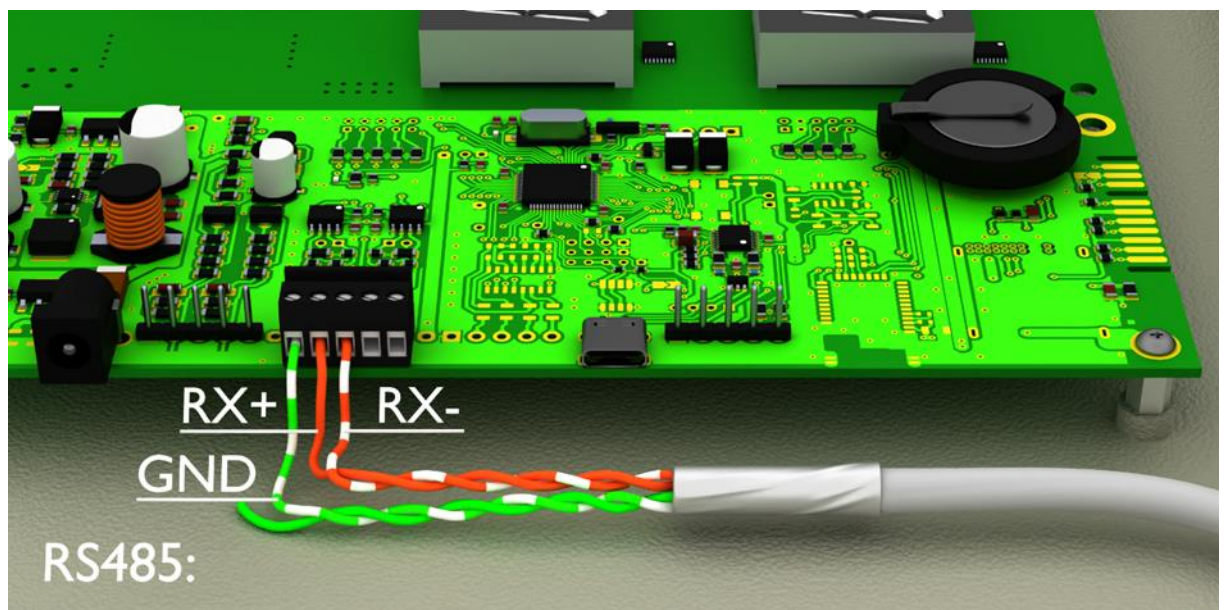



## Connection of the Ethernet cable

Only valid for displays with Ethernet interface (XC4xx-xxx-x-05).

Displays with Ethernet interface are connected with an Ethernet cable cat. 5 or higher. Modern PCs or laptops recognize the cable type automatically.

If your display is operated with older network components, the following cables are required:

- a crosses Ethernet cable cat. 5 or higher for a direct connection to the PC or laptop with the display
- an Ethernet patch cable cat. 5 for the connection of the PC or laptop via a network switch or hub with the display

All other settings (network addresses, protocols, etc.) are set with the 'SolarDisplayConfigurator'.

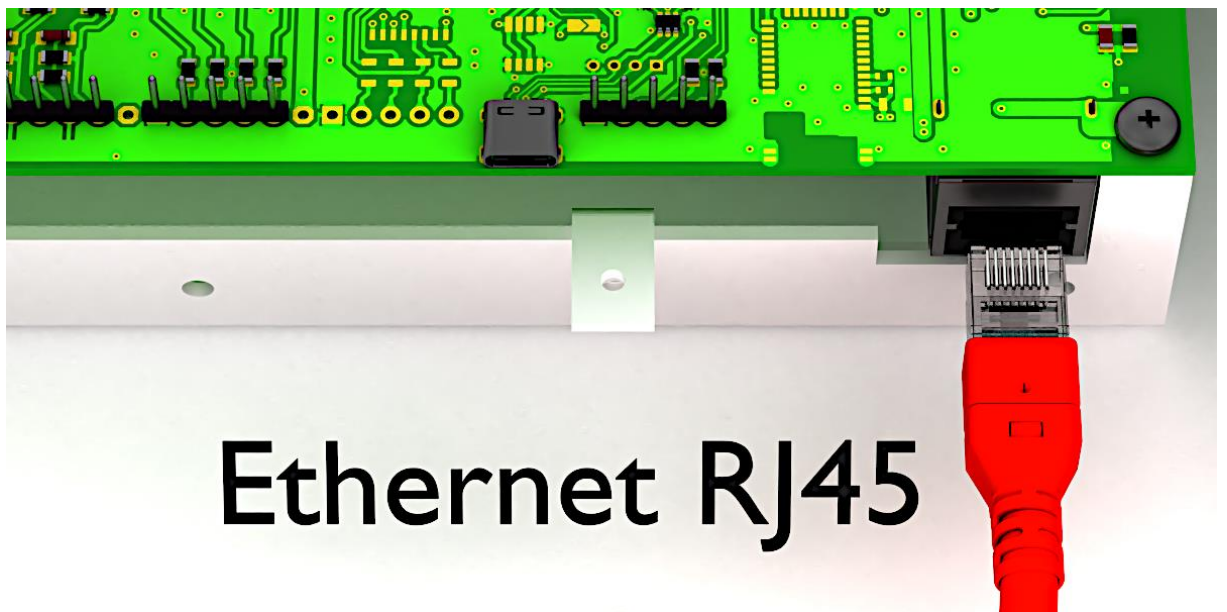

---

## 7 Start-up and configuration

---

Siebert Solar Displays can be configured and operated via various interfaces. In addition to a PC or laptop, depending on the interface of the display, you will also need further tools for configuration/operation.

### Displays with USB interface (XC4xx-xxx-x-03)

The configuration and the changing of values is carried out via the USB interface. A matching USB cable is included in delivery.

The USB socket type C is located on the printed board. It is only accessible when the device is open.

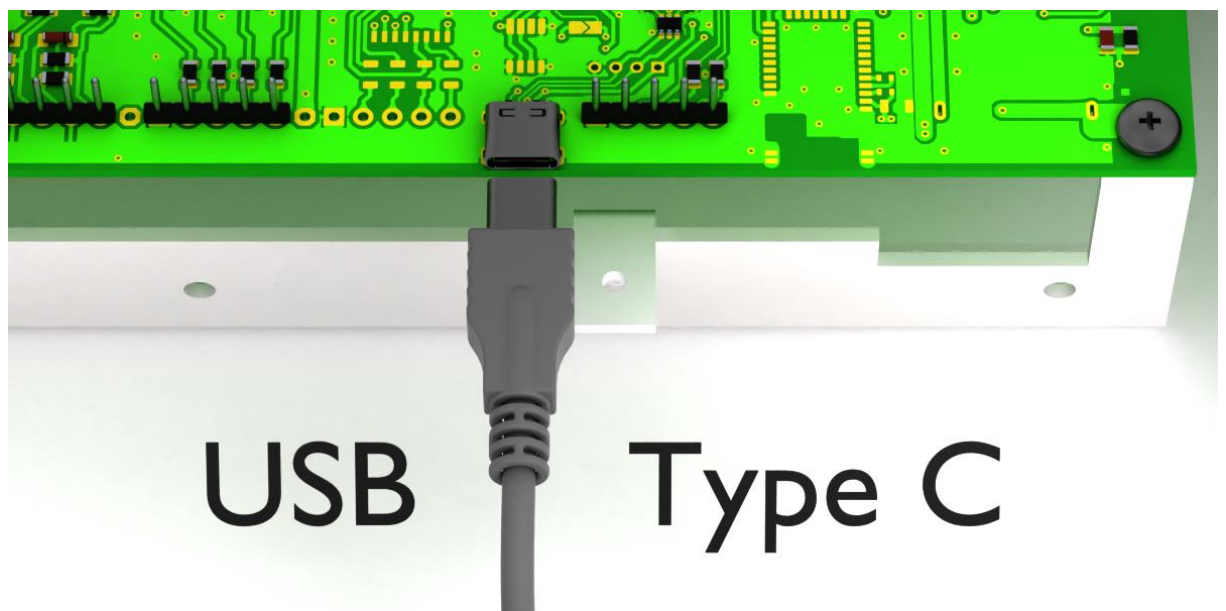

### Displays with Ethernet interface (XC4-xx-xxx-x-05)

The configuration and the changing of values is carried out via an Ethernet cable. All settings (network addresses, protocols, etc.) are set with the 'SolarDisplayConfigurator'.

See chapter 'Connection of the Ethernet cable'

## Configuration of the display

The configuration is only done with the Windows software 'Siebert SolarDisplayConfigurator'.

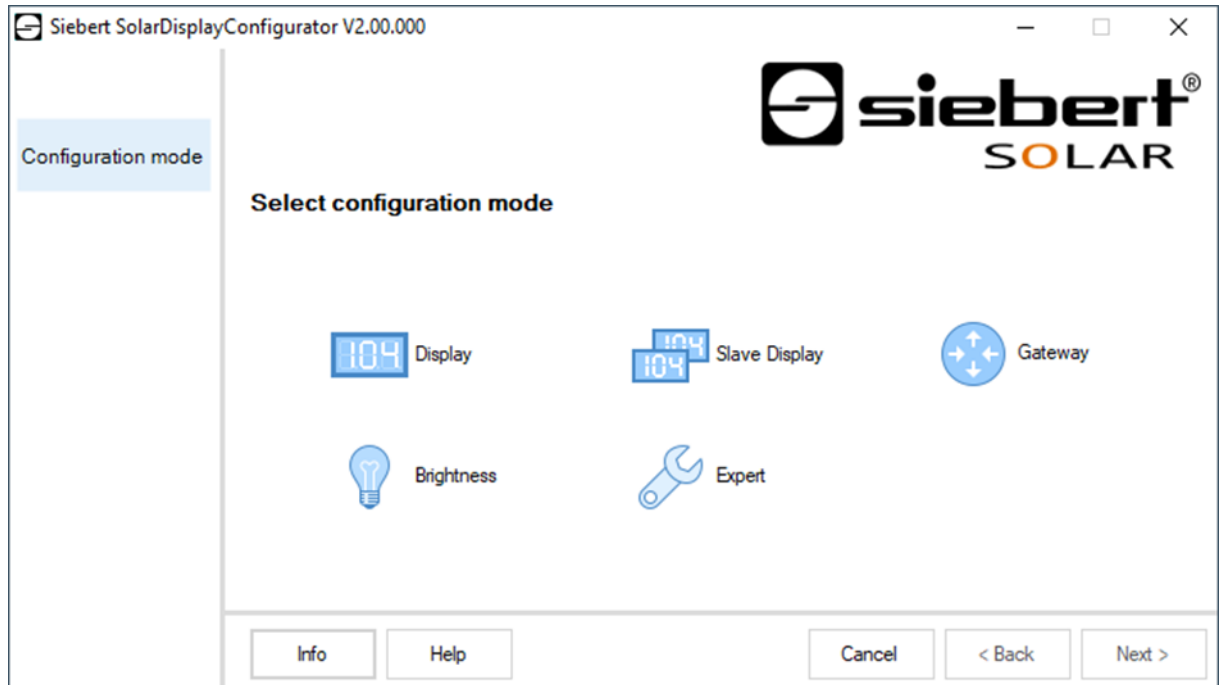

The steps required for configuration are described in detail in the documentation of the 'SolarDisplayConfigurator' program.

After you have successfully completed the configuration, the software is needed only if something changes in the solar system.

## Start-up and test

Expediently perform a functional test before you close the device permanently.

## Controls

On the printed circuit board there is an LED that flashes quickly after starting. After a few minutes the LED turns off.

---

## 8 To close the display

---

### Closing the display for indoor use

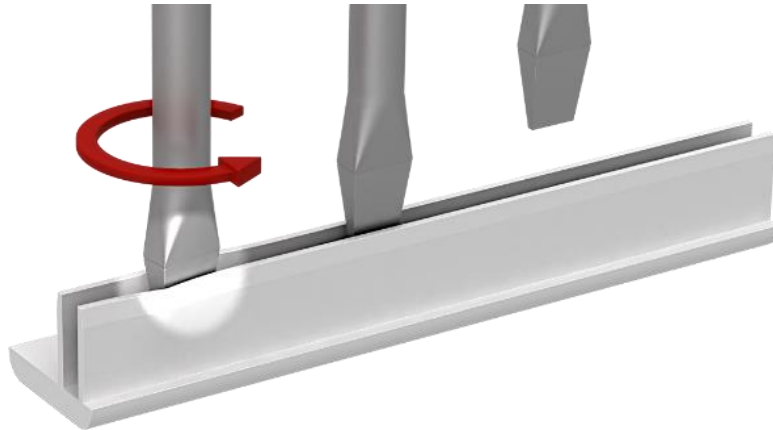

Insert the front pane and the connectors. Spread the connectors slightly with a screwdriver before inserting so that they are stuck firmly in the housing frame. Check that the connectors are fixed so tightly after insertion that they cannot be removed without tools (lever tools).

### Closing the display for outdoor use

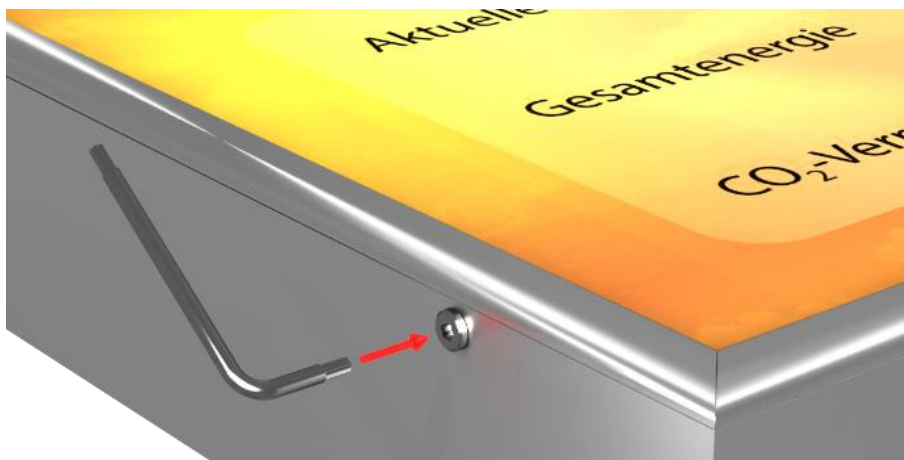

For devices for outdoor use the connectors have to be screwed into the housing frame with torx screws after insertion. For this, use the screwdriver included.

**WARNING!**

If the connectors are not fixed firmly or screwed they can be removed by unauthorized persons or resolve themselves. As a result the front pane can fall out and live parts can be exposed.

## 9 Technical data

The following figures show the housing dimensions and the holes for wall mounting.

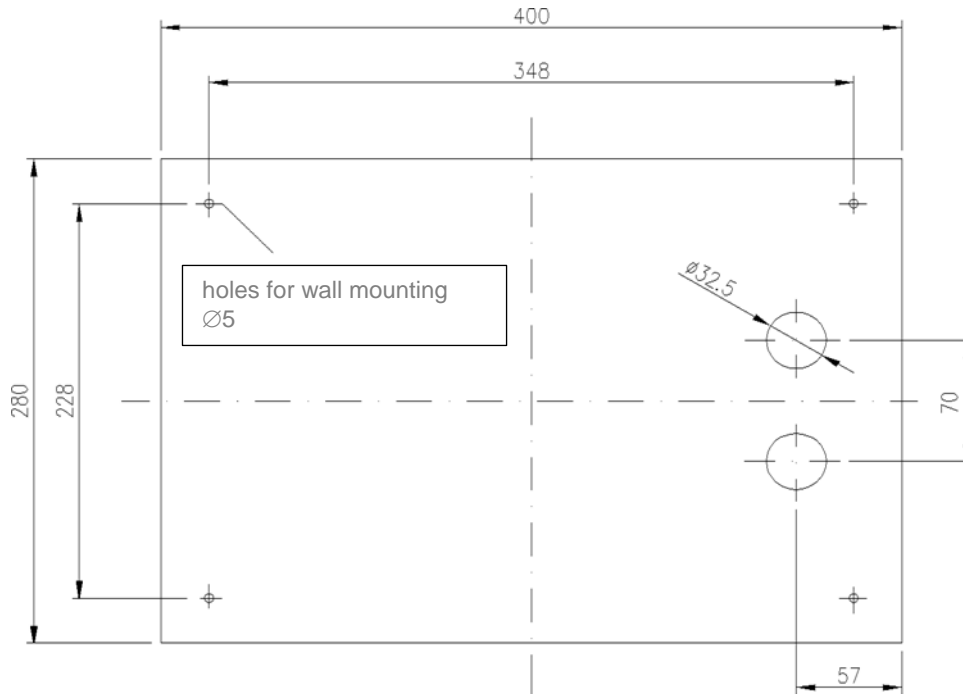

### Series XC420

Dimensions (W x H x D)	400 x 280 x 62 mm
LED display digit height	25 mm
Upper LED display	4 digits
Middle LED display	6 digits
Lower LED display	6 digits
Power supply	100...240 V AC, 50/60 Hz
Power consumption	25 W max.
Protection type	IP40 (IP54)
Weight	approx. 3 kg
Operating temperature	0...40 °C (-20...50 °C)
Storage temperature	-25...85 °C

() Values in brackets are valid for units with equipment package for outdoor use.

---

## 10 SolarDisplayConfigurator

---

### Installation

#### System requirements

With the 'Siebert SolarDisplayCofigurator' Siebert displays are parameterized for solar systems with the help of a PC. The PC must have the following minimum system requirements:

Operating system	Windows 10
Processor	1GHz or higher
RAM	2 GB or higher
Display resolution	VGA (800 x 600 pixels) or higher
Others	.NET Framework 4 Administrator rights during installation Network access (depending on type of display) USB interface Bluetooth (optional, depending on type of display)

#### Starting the installation

Start the Windows Installer package 'SolarDisplayConfiguratorSetup-x\_xx\_xxx.exe' from the data carrier included.

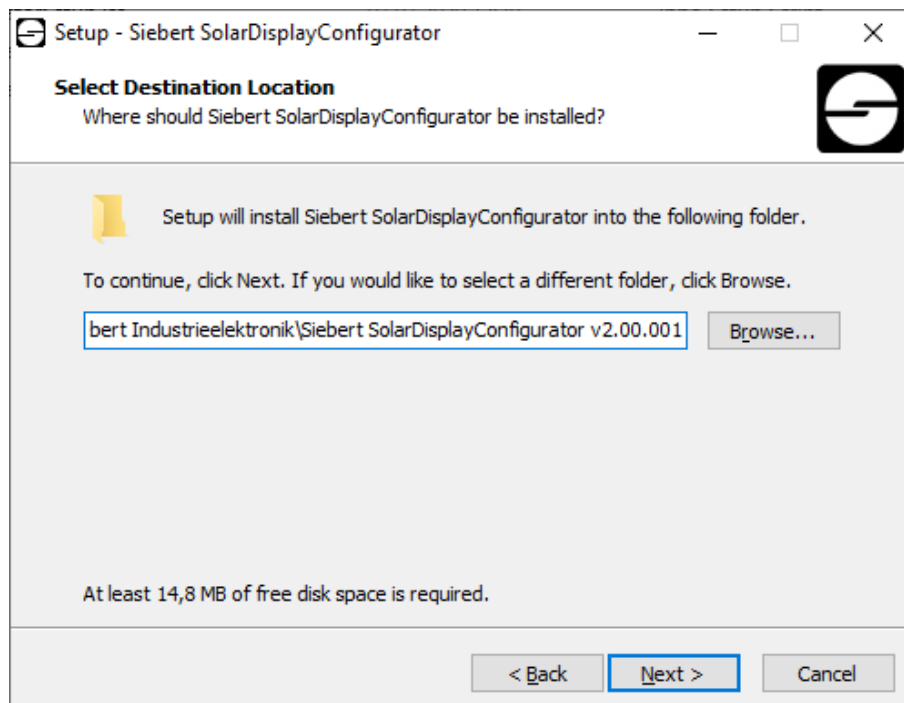

The installer guides you through the installation of Siebert 'SolarDisplayConfigurator'.

A user input from you is only required, if you do not want to install the software in the therefor provided directory file. In this case, please modify the target directory accordingly.

After successful installation, the software can be called up via the Start Menu. Click Start > Siebert > SolarDisplayConfigurator x\_xx\_xxx.

## Deinstallation

To uninstall the Siebert 'SolarDisplayConfigurator' open 'Programmes and Features' via the Windows settings.

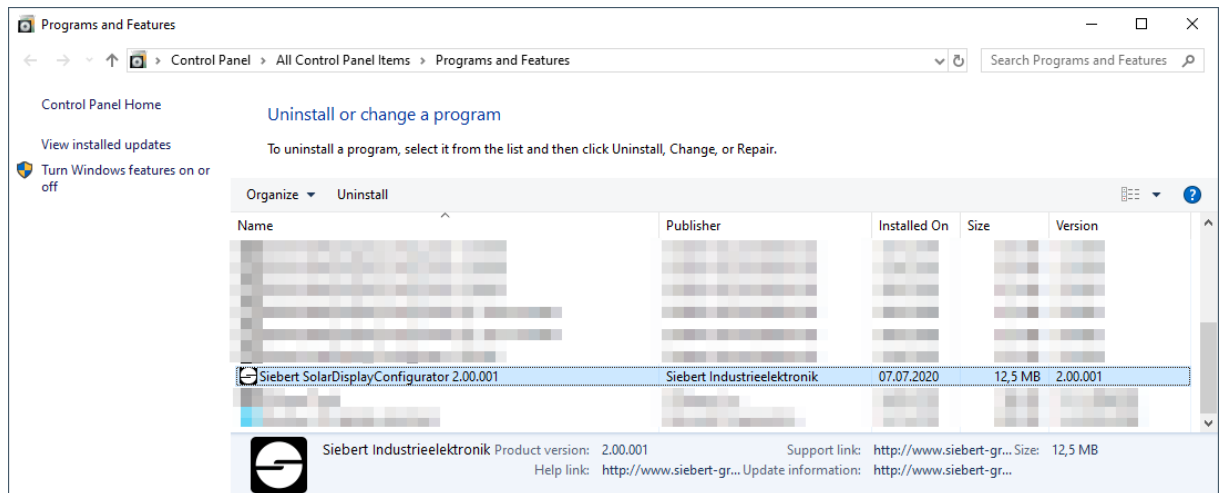

Choose the Siebert 'SolarDisplayConfigurator' from the list and click Uninstall.

## Configuration of the display

### Connecting the display

With displays of the type ...-03 with S0- or RS485 interface the configuration is done via the USB interface of the display. A matching cable is enclosed in delivery.

With displays of type ...-04 the configuration can also be carried out via Bluetooth.

For configuration via Bluetooth, you need a Bluetooth-enabled PC. If your PC does not have a Bluetooth interface, you need a USB-to-Bluetooth converter. Siebert offers such a converter. Before the configuration via Bluetooth can be carried out via Bluetooth, the Bluetooth coupling between the PC and the display must be initialized (see chapter Bluetooth connection)

With displays of the type ...-05 with Ethernet interface the configuration is done via the Ethernet. Please have ready the following items:

A cross-type Ethernet cable if you connect the PC for configuration directly with the display.

A patch cable, if, for configuration, you connect the PC over a switch or router with the display.

### Control concept

The configuration of the display is done in several steps, which you are guided through by the Siebert 'SolarDisplayConfigurator'. Here each step has an own dialog box. As the next step will not be called up before all previous entries are correct a faulty operation is almost impossible.

In the left column of the dialog box the steps required for configuration are listed. The current step is highlighted in color.

The buttons which let you navigate through the various steps are in the bottom line:



With the buttons Next and Back you go forward to the next step or backward to the last step.

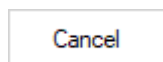

With the button Cancel you can stop the configuration at any time.

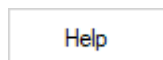

With the button Help you open this operating instructions.

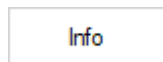

The button Info indicates the version of the software.

In the following the dialog boxes of all steps are described. The sequence of steps varies depending on the configuration settings. For help please read the section on the current step.



## Configuration mode

After starting the software you need to set the configuration mode.

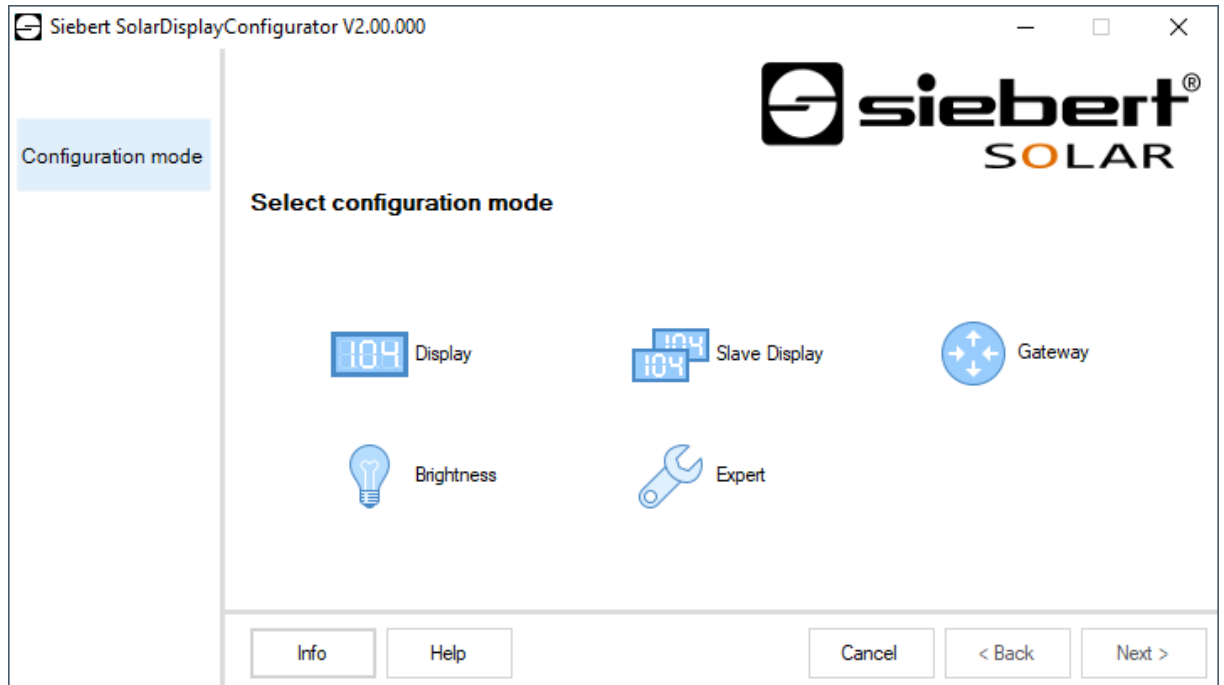

The complete configuration of the display resp. of the gateway is set in mode 'Configuration' or 'Gateway'. Thereby all required parameters are set.

A gateway collects data from data loggers that do not have a network interface and makes that data available in the network for the display.

With the mode 'Brightness' the luminosity of the display can be modified, all other parameters remain unchanged. The brightness can be set at a later point of time.

With the mode 'Expert' all individual display systems, resp. special gateway solutions are configured. A special configuration data file is not needed.

Through the 'slave display' mode, a display can be configured to not receive its data as a standard display from the data logger, but via a serial connection from the standard display itself.

The standard display and daughter display must have the same display layout.

## Daughter displays

Each standard display is automatically configured to send the displayed data via the second RS485 interface.

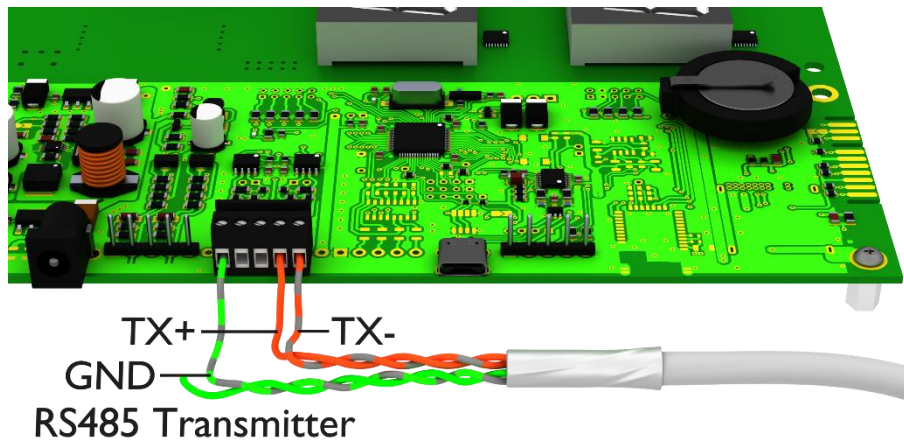

The daughter display can evaluate and display the data of the standard display via its first RS485 interface.

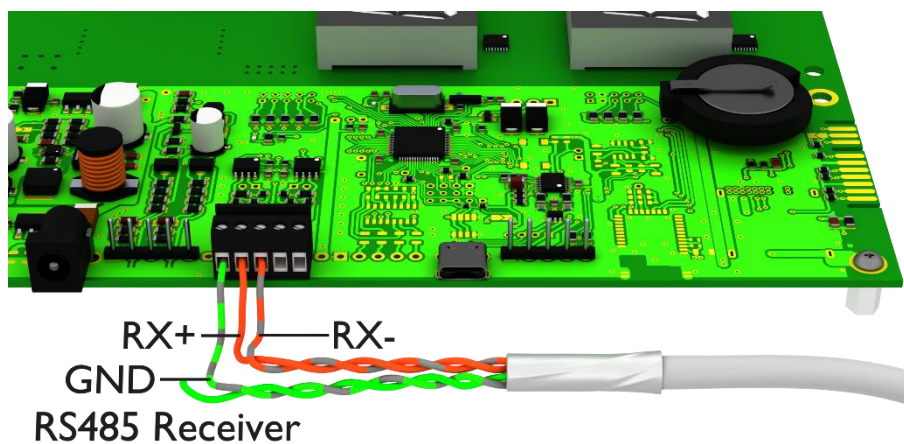

The daughter display also sends the displayed data via the RS485 interface so that several daughter displays can be cascaded.

First, the standard display must be configured via the "Display" mode. Then restart the 'SolarDisplayConfigurator' and configure the daughter display using the "Daughter Display" mode. You can configure any number of daughter displays to the standard display configured in the first step.



If you have decided on the expert mode then select whether you want to parameterize an individual display by clicking 'XC-Board®' or a gateway solution. Then click 'Next'.

## Interface

Here you set via which interface the display is connected with the inverter.



If the inverter, resp. the data logger is connected to the display via a S0 interface, resp. a pulse exit, please select 'S0 Pulse'.

For displays which are connected to the converter, resp. the data logger via a serial interface select 'RS485'.

For displays which are connected to the PC via a network choose 'Ethernet'.

### Selection of display or gateway

In the next step all displays connected to the PC via the configuration interface (Ethernet, USB or Bluetooth) are automatically recognized.

To select the display double-click the desired line in the display list. The selected display is marked by a green arrow. If only one display is recognized this display is automatically selected.

### Selection of the display with USB or Bluetooth connection

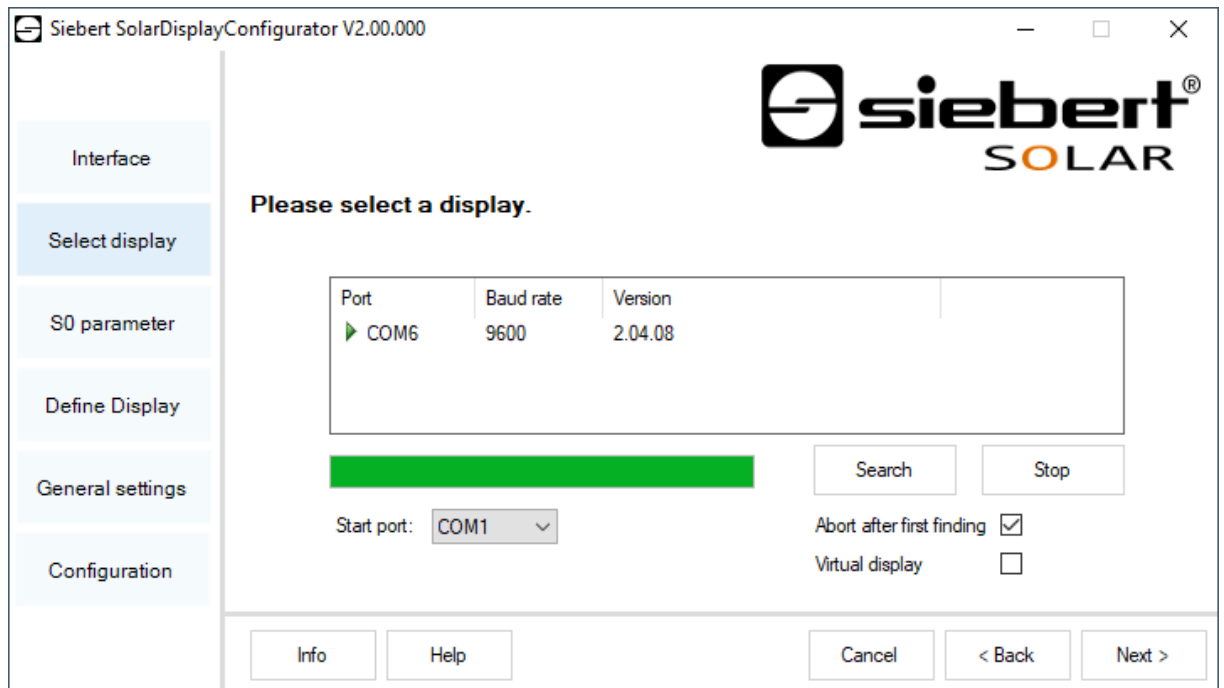

By clicking the button 'Search' the recognition of the display can be restarted at any point of time. By clicking the button 'Cancel' an already started recognition is stopped.



#### Interfaces

For technical reasons, both USB interfaces and Bluetooth interfaces are called COM interfaces by Windows.

The list box 'Start-Port' shows all interfaces available on your PC. Among those you will also find virtual interfaces which are created p. e. by USB-serial adapters or Bluetooth interface. With the interface selected here the display recognition starts. If the option 'Abort after first find' is activated, the display recognition is stopped, when the first display is recognized. Displays connected to interfaces, on which a recognition was not performed yet, do not appear on the display list. Deactivate this option if you have connected various displays and wish to enter all displays.

By activating the option 'Virtual display' a fictive display is added to the display list. If you perform the configuration of this fictional display the parameterization is saved in a file.

By clicking the button 'Next', the parameters of the selected display are read out.

## Selection of the display or the gateway with Ethernet connection

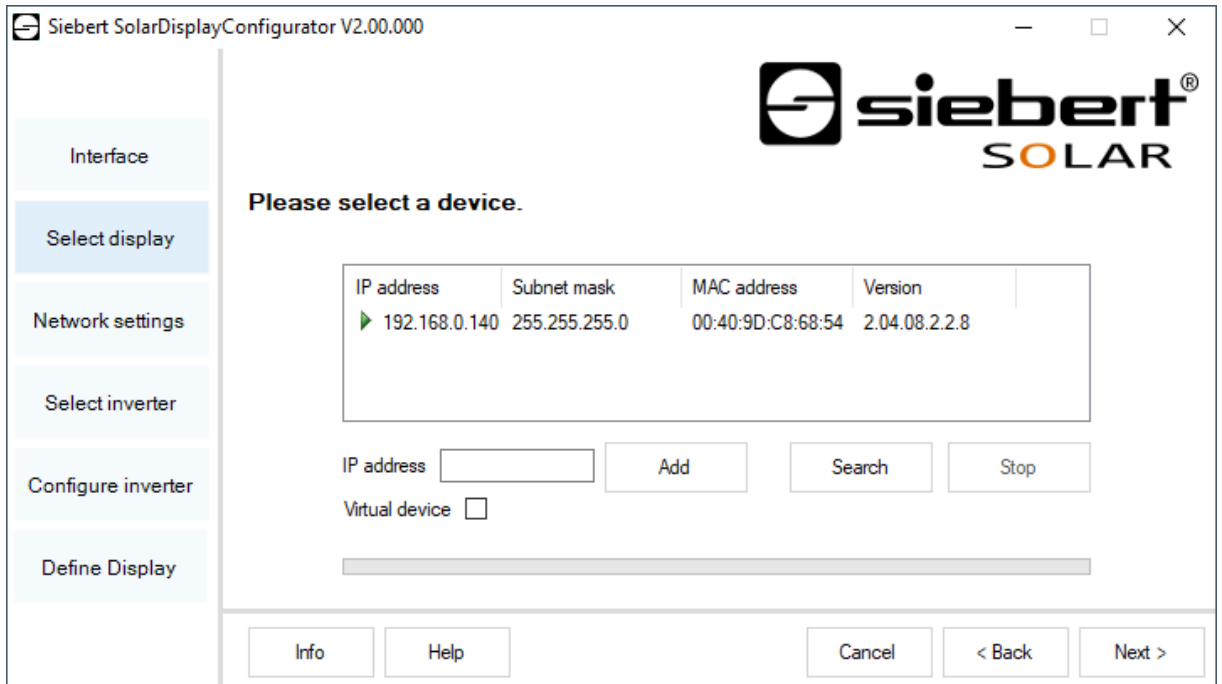

IP address	Subnet mask	MAC address	Version
▶ 192.168.0.140	255.255.255.0	00:40:9D:C8:68:54	2.04.08.2.2.8

By clicking the button 'Search' button, the recognition of the display can be started new at any time.

In the field 'IP address' you can enter the IP address of the display manually. Then click the 'Add' button, so that the display is added to the display list.

By activating the option 'Virtual display' a fictive display is added to the display list. If you perform the configuration of this fictional display the parameterization is saved in a file.

By clicking the button 'Next', the parameters of the selected display are read out



### IP address

Make sure that your PC and the display are in the same network segment. Displays outside the network segment of your PC are recognized, but a connection is not possible. If necessary adjust the IP address of your PC to the IP address of the display.

## Network set-up

If the display is connected to the PC via a network, the network parameters have to be set under which the display has to be contacted in the network.

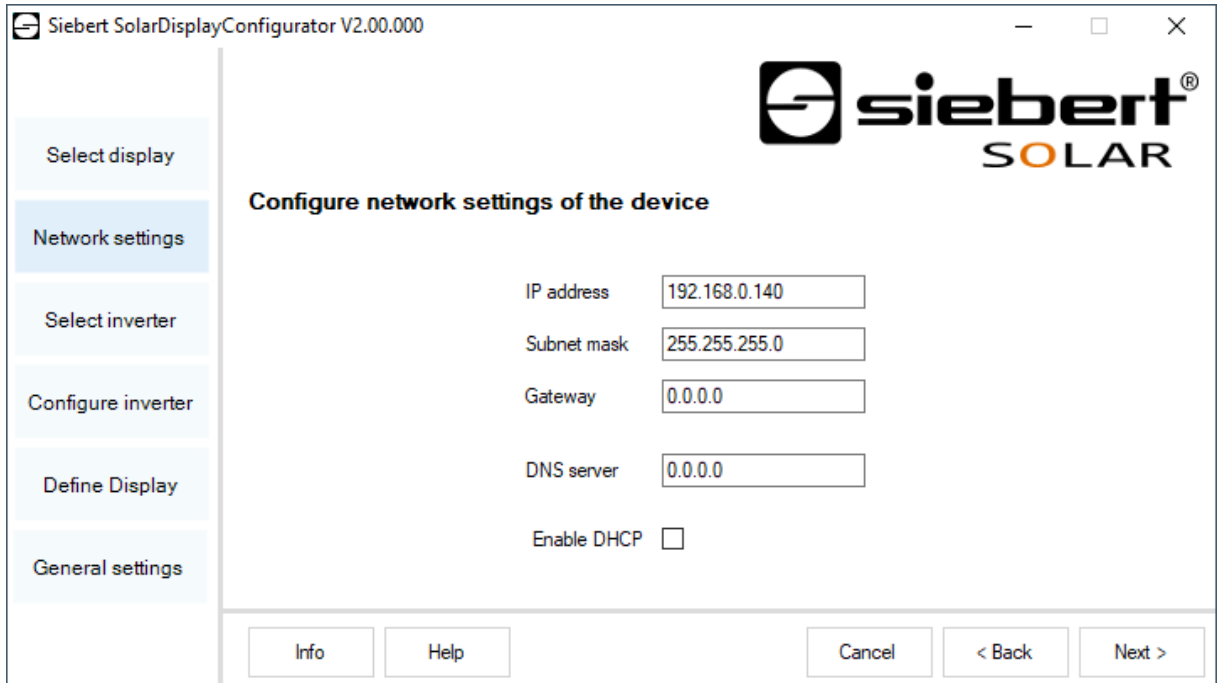

Choosing the option 'DHCP' (Dynamic Host Configuration Protocol) the display is integrated automatically to the existing network. A DHCP server, transmitting IP address, subnet mask and gateway of the display, has to be available in the network.

Alternatively, you can set the network parameters of the display manually.

In the field 'IP address' enter the desired network address of the display. Make sure that the address is not used by another network participant already. If in doubt, please contact your network administrator.

In the field 'Subnet mask' enter the Subnet mask number. This number, together with the IP address, specifies to which network segment the display belongs. Usually values 0 and 25 are used for standard Subnet masks, p. e. 255.255.255.0.

In the field 'Gateway' enter the IP address of the IP router, which is located in the same network segment. This entry is only necessary if there is such a gateway and the display is to communicate outside the limits of the network segment in which it is located.

In the field 'DNS-Server' (Domain Name System Server) you enter the IP address of the DNS server. This entry is only necessary if you work with name resolutions for the inverters or data loggers located in the network.

## S0 parameter

If the display or the gateway is connected to an inverter or a data logger via the S0 interface the following data of the solar system have to be set:



The screenshot shows the 'S0 settings' window of the Siebert SolarDisplayConfigurator V2.00.000. The window has a sidebar on the left with navigation options: 'Select display', 'S0 parameter' (selected), 'Define Display', 'General settings', 'Power saving mode', and 'Configuration'. The main area contains the following settings:

- Maximum power: 10 kW (dropdown)
- Max. pulse rate: 6000 Pulse / kWh
- Pulse rate: 5000 / 1 Pulse / kWh
- Generated Energy: 0 kWh (dropdown)
- Update time: 1 s (spinner)
- Simulation:

At the bottom of the window are buttons for 'Info', 'Help', 'Cancel', '< Back', and 'Next >'.

Enter the peak performance of the solar system in the input field 'Maximum power' and select the corresponding unit value in the drop-down list. Based on the maximum power the maximum possible pulse rate is calculated.

In the input fields for the 'Pulse rate' enter the same pulse rate value as set in your solar system. In the first input field the number of pulses is set. In the second field enter the number of kilowatt hours [kWh] to which the number of pulses refer to.



### High resolution by maximum possible pulse rate

To obtain the highest possible resolution of the displayed performance the value for the pulse rate should be close to the value of the maximum possible pulse rates.

Whether and in which way you may adjust the pulse rate of your solar system please see in the manual of the device to which S0 interface the display is connected to.

In the input field 'Generated Energy' you can enter the energy of the solar system before installation of the display. Select the appropriate value unit in the drop-down list. This energy is included in the calculation of the total performance or of total CO<sub>2</sub> reduction.

The already generated energy you can take p. e. from your data logger or from the electric meter at the feed point.

Certain electric meters do not transmit the S0 pulses equidistant, but the pulses are collected and transmitted as pulse accumulations. This can lead to variations in the displayed performance value. These variations can be suppressed by increasing the 'Update time'.



## Select inverter

If the display or the gateway is connected to an inverter, resp. to a data logger via the serial interface or Ethernet, the type of inverter, resp. of the data logger and the used data protocol must be set.

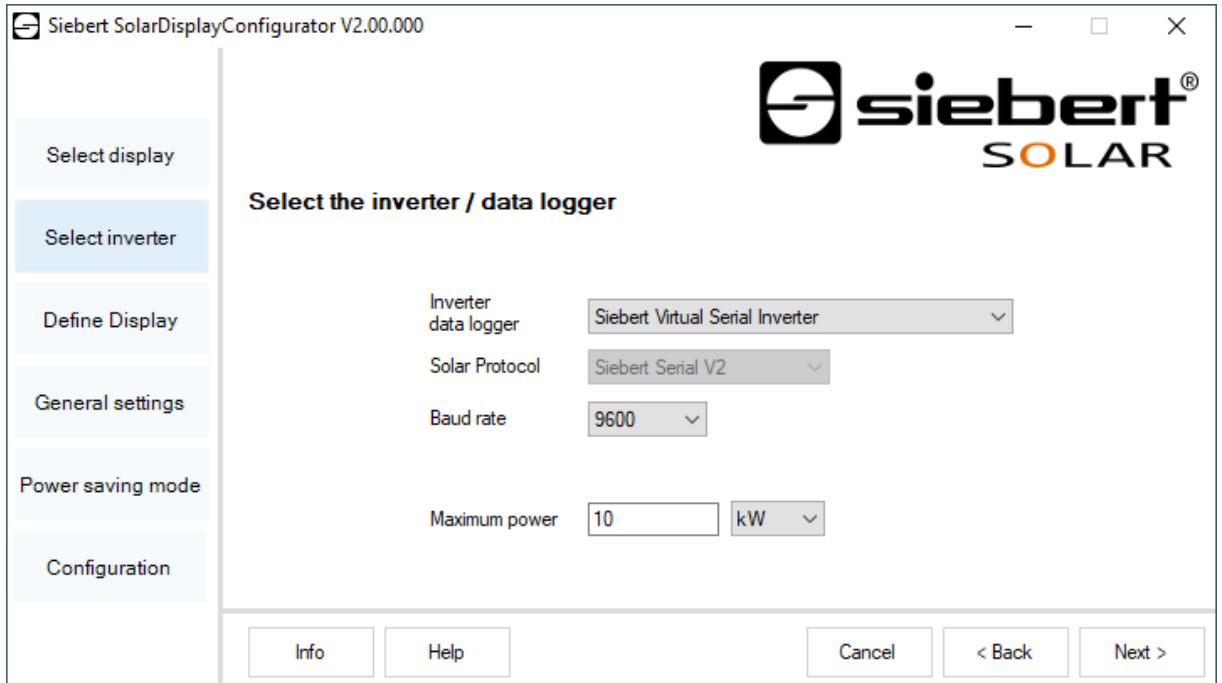

Choose the inverter, resp. data logger which is connected with the display in the dropdown list 'Inverter/Data logger'.

In the dropdown list 'Solar Protocol' you select the protocol of the inverter, resp. data logger. This setting is only necessary if your inverter or data logger has multiple output protocols. Please refer to the manual of your inverter or data logger.

In the dropdown list 'Baud rate' you select the transmission speed used by the inverter or data logger. This setting is only necessary if your inverter or data logger is connected to the display via the serial interface. Please refer to the manual of your inverter or data logger.

In the input field 'Maximum Power' enter the peak performance of your solar system and select the corresponding unit value in the dropdown list.



### Inverter is not in the list?

If your inverter, resp. data logger is not in the list select "Unknown".

Check from the manual of the inverter, resp. data logger if one of the protocols from the list 'Solar Protocol' is supported.

## Set the inverter

Data loggers with network interface have to be configured via their network parameters in the display so that it can make the connections for data transmission.

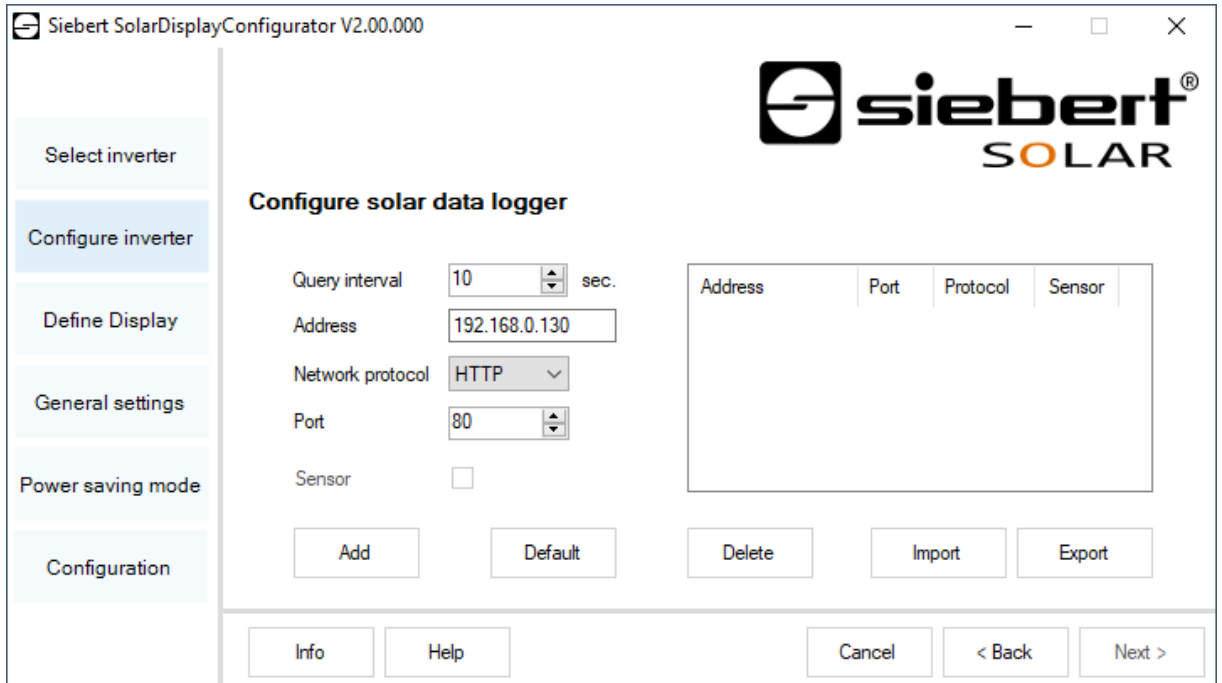

In the field 'Address' you enter the IP-address of the data logger in the network.

If the data logger supports multiple network protocols select the desired protocol in the dropdown list 'Network protocol'. In the field 'Port', you can change the network port which is to be used for the chosen network protocol. With the selection of the network protocol the port which is to be used standardly by the data logger is predefined. Then click 'Add' to apply the settings to the data logger list.

In the field 'Query interval' you can enter the time interval in seconds which is used to query the data from the data loggers. The query interval applies for all configured data loggers.

Some data loggers can be equipped with separate sensors, which enable the data logger to provide further measured values. The 'Sensor' option can be selected for these data loggers so that the additional measured values for user-defined displays are available and can be displayed.

Using the button 'Export', the data logger list can be stored in a csv file. The data logger list can be created from a csv file using the button 'Import'.

An entry in the data logger csv file has the following syntax:

```
<IP-Addr Byte1>;<IP-Addr Byte2>;<IP-Addr Byte3>;<IP-Addr Byte4>;<Port>
```

If you configure multiple data loggers the display takes the data from each data logger and calculates the total values of the solar system.

To remove already configured data loggers from the data logger list mark the data loggers and click 'Delete'.

By clicking 'Standard' in the fields 'Query interval', 'IP address', 'Network protocol' and 'Port' the standard values are set for the selected type of data logger.



### IP address and network segment

Make sure that the data logger and the display are in the same network segment if you do not use a gateway.  
Make sure that no IP addresses are assigned twice in the network.

### Server settings of the display

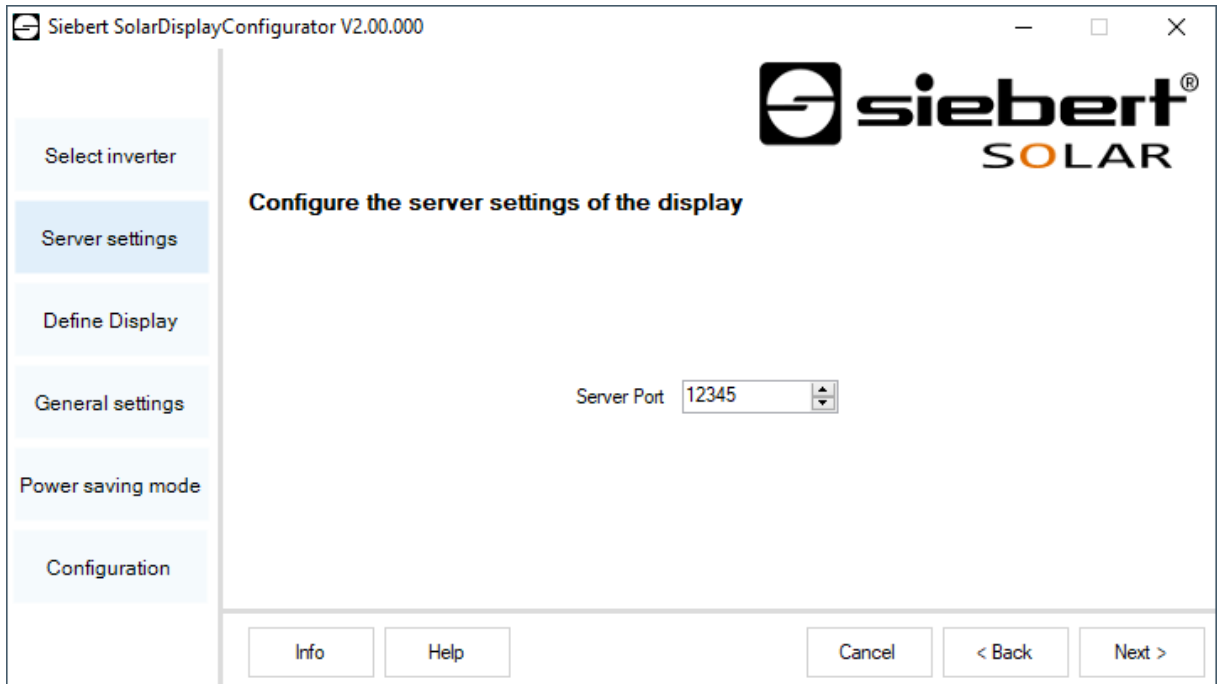

The screenshot shows the 'Siebert SolarDisplayConfigurator V2.00.000' window. On the left is a vertical navigation menu with options: 'Select inverter', 'Server settings' (highlighted), 'Define Display', 'General settings', 'Power saving mode', and 'Configuration'. The main area features the Siebert SOLAR logo and the title 'Configure the server settings of the display'. A 'Server Port' label is followed by a text box containing '12345' and a small up/down arrow icon. At the bottom, there are five buttons: 'Info', 'Help', 'Cancel', '< Back', and 'Next >'.

For some Ethernet data loggers, the display must act as a server, and the data logger connects to the display as a client. 'Server Port' specifies the network port via which the client can connect to the display. In order for the data logger to connect to the display, the IP address of the display and the server port of the display must be entered in the configuration on the data logger.

## Define the display

In this step the illustration of information of the display is defined. It is defined which line shows which value and how many digits each value has and in what units the values are displayed.

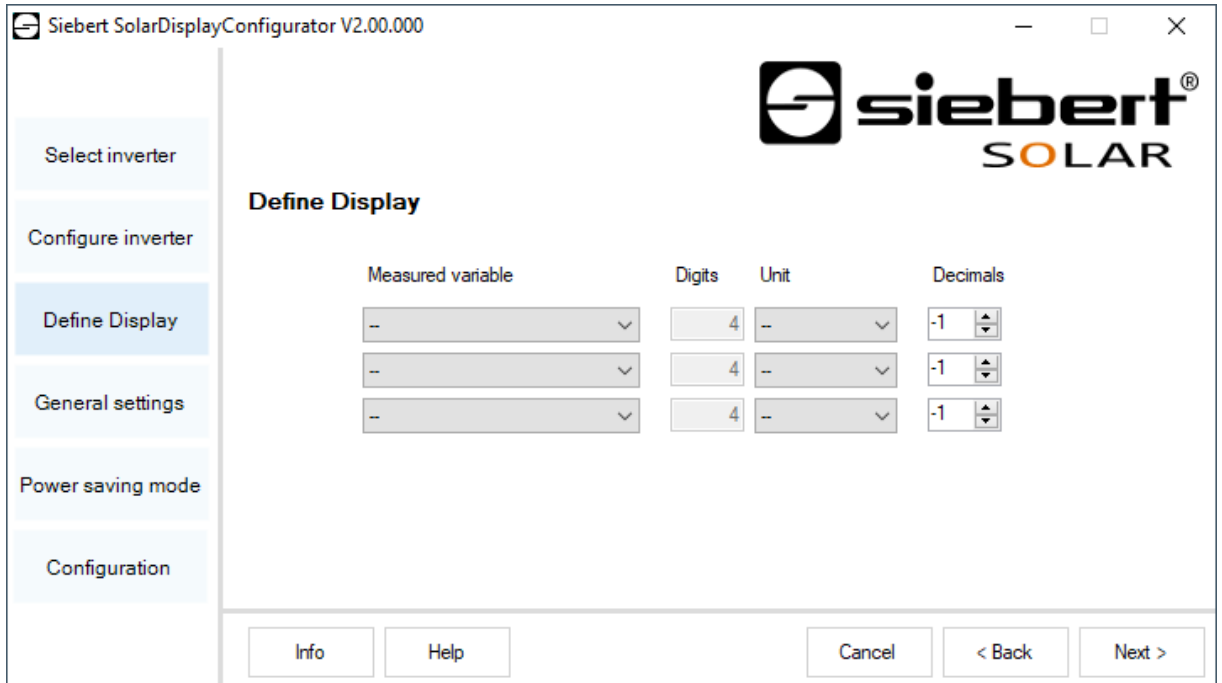

The screenshot shows the 'Define Display' window in the Siebert SolarDisplayConfigurator. The window title is 'Siebert SolarDisplayConfigurator V2.00.000'. The sidebar on the left contains the following options: 'Select inverter', 'Configure inverter', 'Define Display' (highlighted), 'General settings', 'Power saving mode', and 'Configuration'. The main area is titled 'Define Display' and contains a table with four columns: 'Measured variable', 'Digits', 'Unit', and 'Decimals'. Each row in the table has a dropdown menu for 'Measured variable', a text input field for 'Digits' (all set to '4'), a dropdown menu for 'Unit', and a spinner control for 'Decimals' (all set to '-1'). At the bottom of the window, there are buttons for 'Info', 'Help', 'Cancel', '< Back', and 'Next >'.

Measured variable	Digits	Unit	Decimals
--	4	--	-1
--	4	--	-1
--	4	--	-1

In the column 'Measured variable' you choose what line of the display shows which measured variable.

In the column 'Digits' the number of digits for the corresponding line is set.

In the column 'Unit' the physical unit of the measured variable is set.

In the column 'Decimals' the number of digits after the decimal point is set. The value '-1' causes, that the number of digits after the decimal point are automatically calculated by the 'SolarDisplayConfigurator'.

## General settings

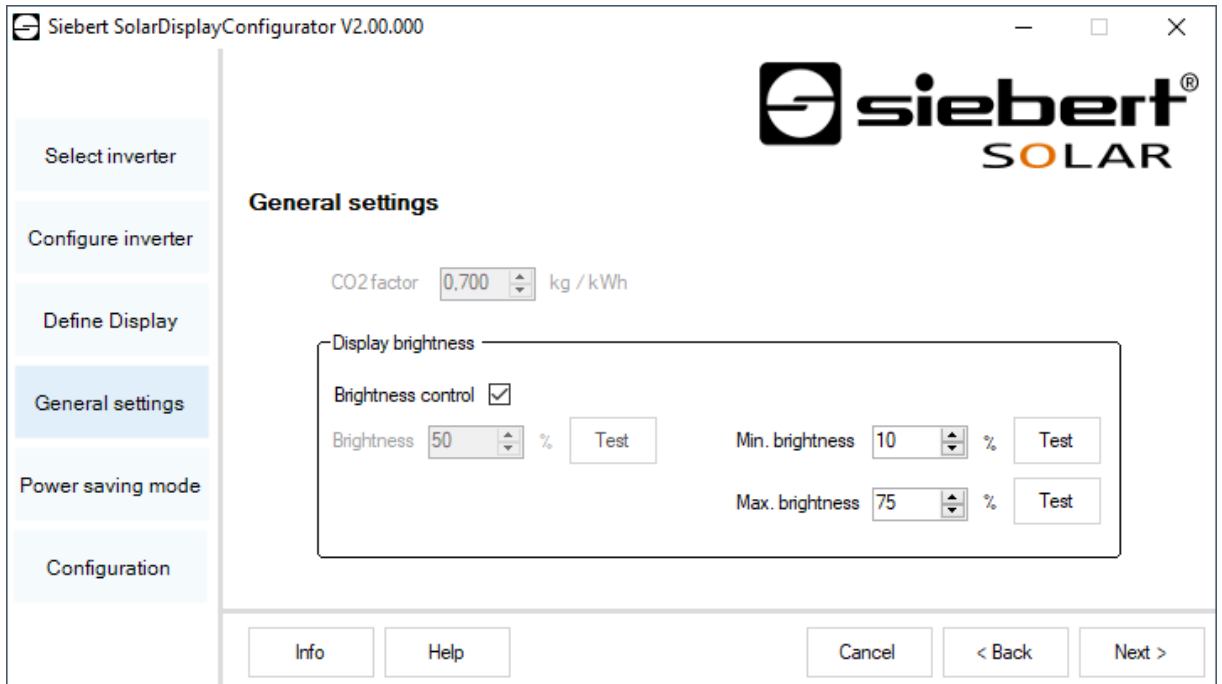

In the field 'CO2 factor', the conversion factor, which is needed to calculate the CO2 reduction out of the total energy, is determined.



### Note

The CO2 reduction is a measure for the contribution of climate protection. The CO2 factor varies regionally and depends on the mix of electricity as well as the technology to generate electricity. Your power supply company can tell you the height of your CO2 factor of the electricity supplied to you.

## Power saving mode

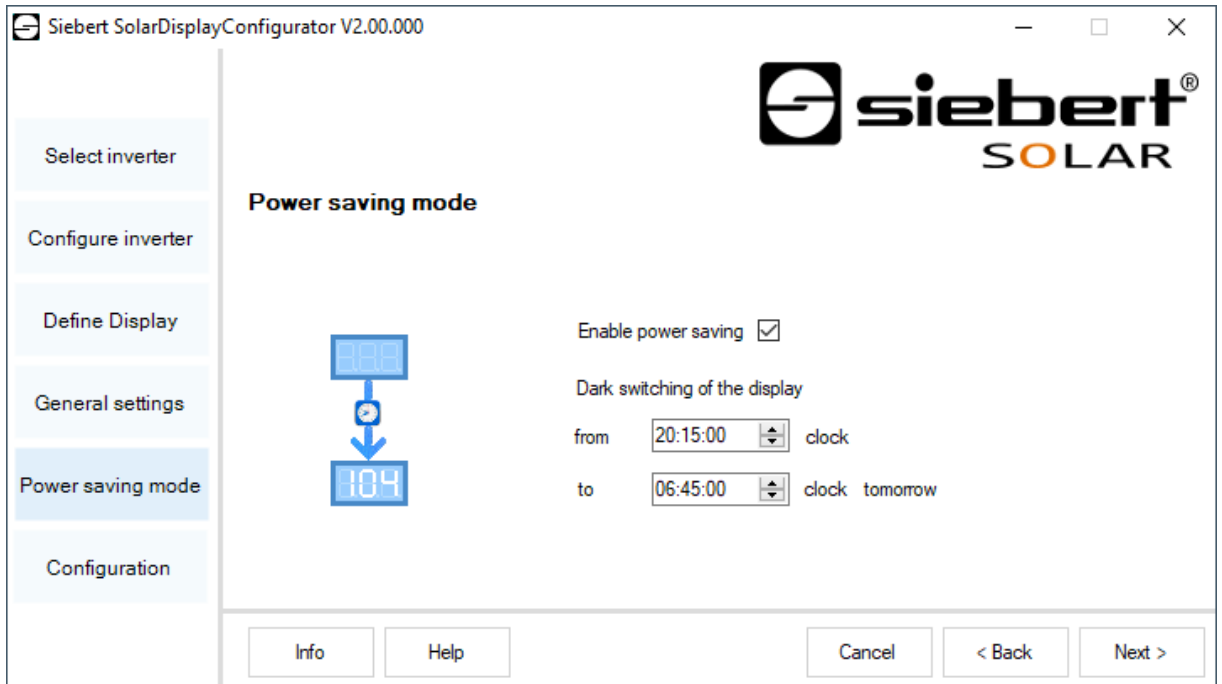

The screenshot shows the 'Power saving mode' configuration window in the Siebert SolarDisplayConfigurator V2.00.000. The window has a sidebar on the left with the following menu items: 'Select inverter', 'Configure inverter', 'Define Display', 'General settings', 'Power saving mode' (highlighted), and 'Configuration'. The main area is titled 'Power saving mode' and features the Siebert SOLAR logo in the top right. A central graphic shows a blue LED display with '888' above a power button icon and '104' below it. To the right, the 'Enable power saving' checkbox is checked. Below it, the 'Dark switching of the display' section is configured with 'from 20:15:00 clock' and 'to 06:45:00 clock tomorrow'. At the bottom, there are buttons for 'Info', 'Help', 'Cancel', '< Back', and 'Next >'.

At this point, the energy saving mode can be switched on and off. When the energy saving mode is activated, the display is darkened for the defined period of time. This means that the LED display of the display is switched off and on at a specific time.

## Brightness



The static brightness of the display can be set with the entry field 'Brightness'. The display then shines constantly with the set value.

If the display has a light sensor, you can activate this sensor via the 'Brightness control'. The brightness of the display varies, depending on the ambient brightness, between the values given in the entry fields 'Min. brightness' and 'Max. brightness'. Since the LEDs of the display shine even brighter, the brighter the ambient conditions are, the optimum readability of the display is guaranteed.



### Automatic brightness control

If the display has no light sensor this function is not supported.

Click on 'Test' to check the set brightness values of the display.

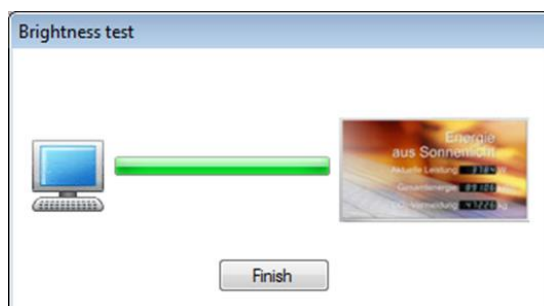

The dialog box 'Brightness test' appears and the luminosity of the display is set to the defined values.

Then click the 'Finish' button to complete the test. The original settings are transmitted back to the display.

### Configuration file

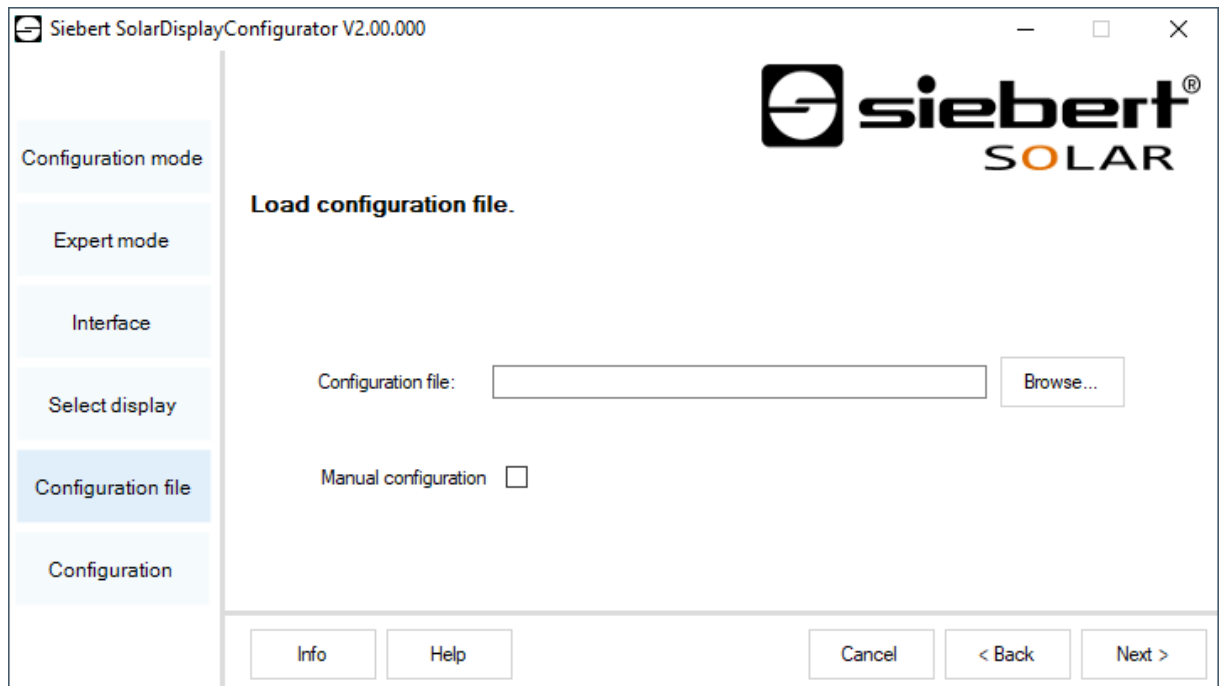

This step allows the configuration of the display with the help of a configuration file. This is necessary if the display does not meet the standard program or you want to use the configuration file that was created by a virtual display. Click 'Browse' to select the desired configuration file and then click 'Next'.

### Inverter Interface Gateway



If you are in 'Gateway' mode, you must select the interface of the inverter to be connected to the Siebert Ethernet Gateway. The data of the inverter can then be queried and displayed by a Siebert solar display with an Ethernet interface from the Siebert Ethernet Gateway.



## Complete configuration

In this step you transfer the previously made settings to the display.

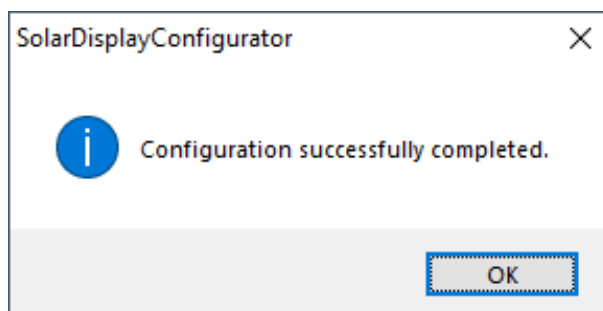
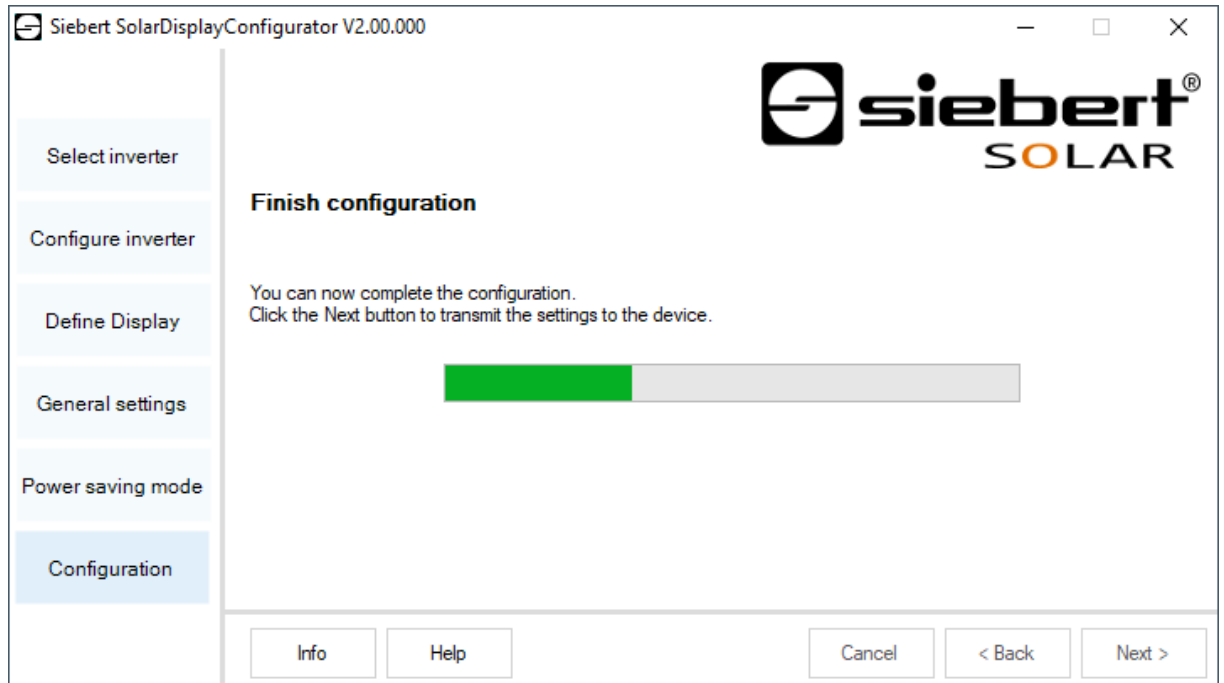

Click 'Next' to start the transfer of the configuration. After successful configuration of the display the shown dialog box appears.

Then click 'OK', this ends the 'SolarDisplayConfigurator' and the display is successfully configured.

If you have configured a virtual display the settings are saved in a configuration file and the memory location is shown in a display box.



### IP address

Make sure that your PC and the display are in the same network segment. Displays outside the network segment of your PC are recognized, but a connection is not possible. If necessary adjust the IP address of your PC to the IP address of the display.

## Bluetooth-connection

For displays of type ...-04 the configuration can additionally be done via Bluetooth.

This exemplarily describes the Bluetooth installation and the connection with a Siebert display for a Bluetooth USB adapter.

This requires that the Bluetooth USB adapter is used with the standard Windows drivers and no additional driver software is required. If your Bluetooth USB adapter requires special drivers observe the documentation of your adapter.

### Installation

Plug the Bluetooth USB adapter into an available USB port of your PCs and wait for the automatic hardware recognition from Windows. After the message 'The device was installed and is ready to use' the Bluetooth symbol appears in the taskbar.

Once the Bluetooth USB adapter is successfully installed the coupling (pairing) between the Bluetooth module of the display and the Bluetooth USB adapter has to be established.

The coupling is absolutely necessary so that the 'SolarDisplayConfigurator' is connected via a virtual COM port.

### Coupling via Windows 10

#### Establish the coupling

Open the Windows settings (p.e.: Windows-button + i) and after select the point 'devices'.

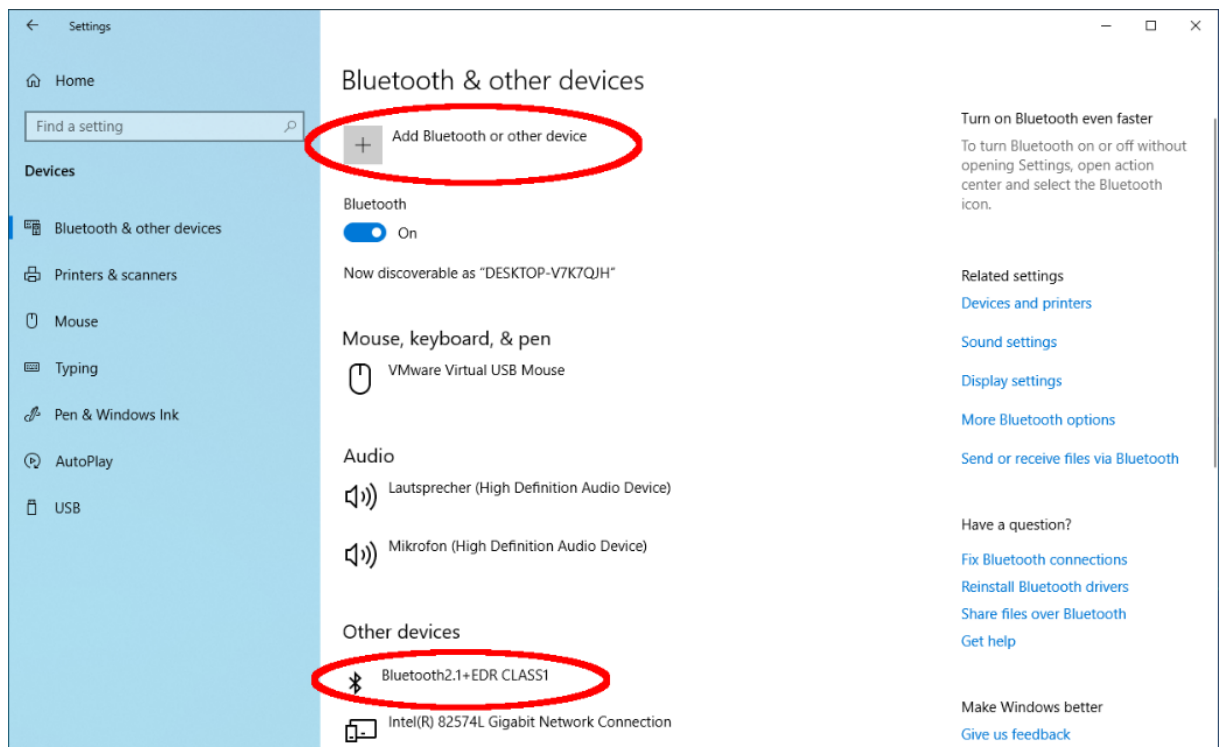

Find your Bluetooth adapter under 'Other devices'.

To connect the Bluetooth adapter to the display, click on 'Add Bluetooth or other device'.

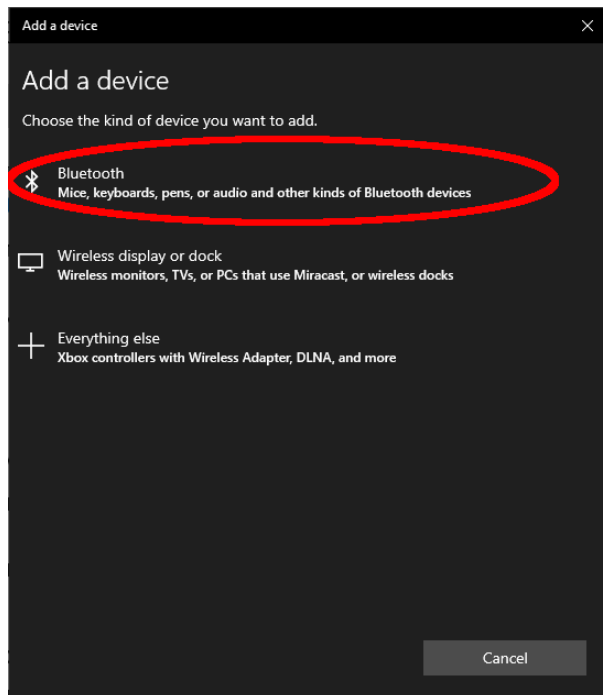

Under 'Add Device', select 'Bluetooth'. Windows will search and display Bluetooth devices.

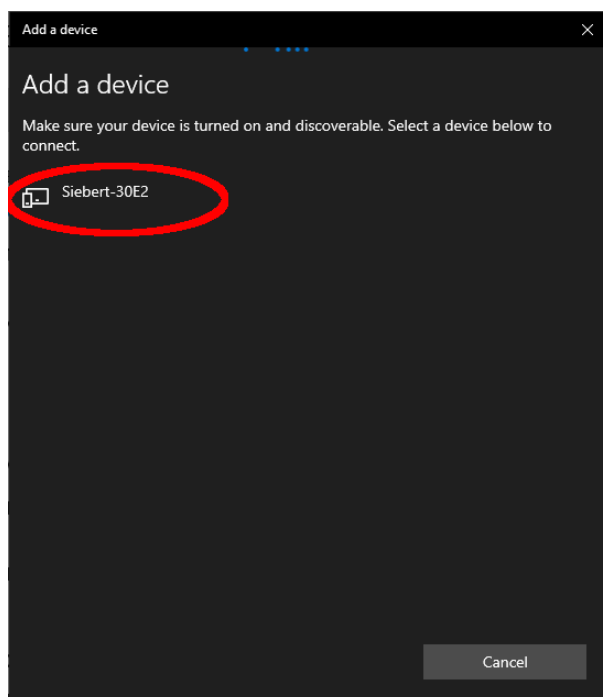

Select the Siebert-xxxx device. Several displays are distinguished by the last four digits of the Bluetooth ID (xxxx).

## Testing the coupling

Open the Windows settings (p.e.: Windows-button + i) and after select the point 'devices'.

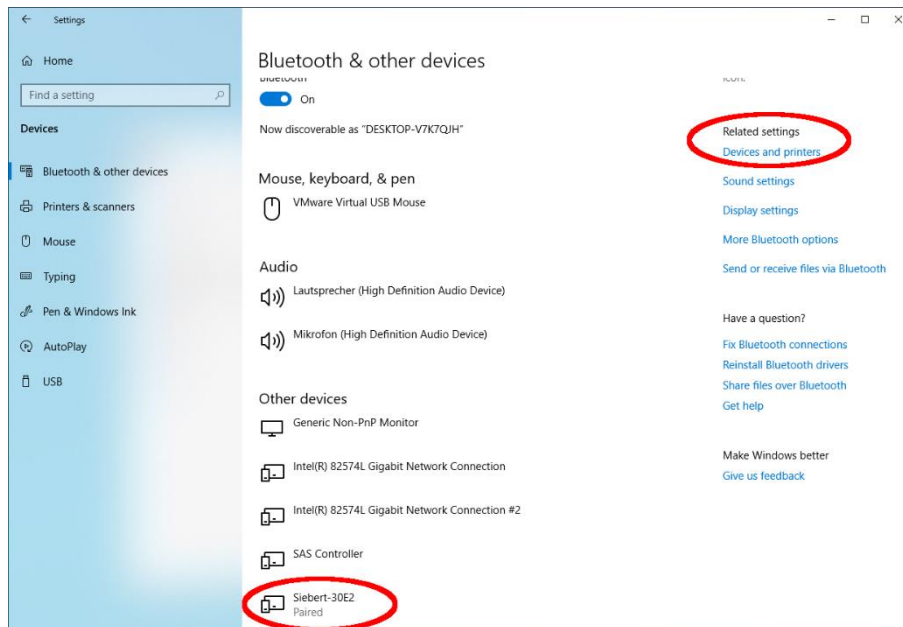

The connected display appears under 'Other devices'.

For communication, the display uses the Bluetooth profile 'Serial Port Device'.  
For this purpose a virtual COM port is created.

To get detailed information about Bluetooth communication, select 'Devices and Printers' under 'Related Settings'.

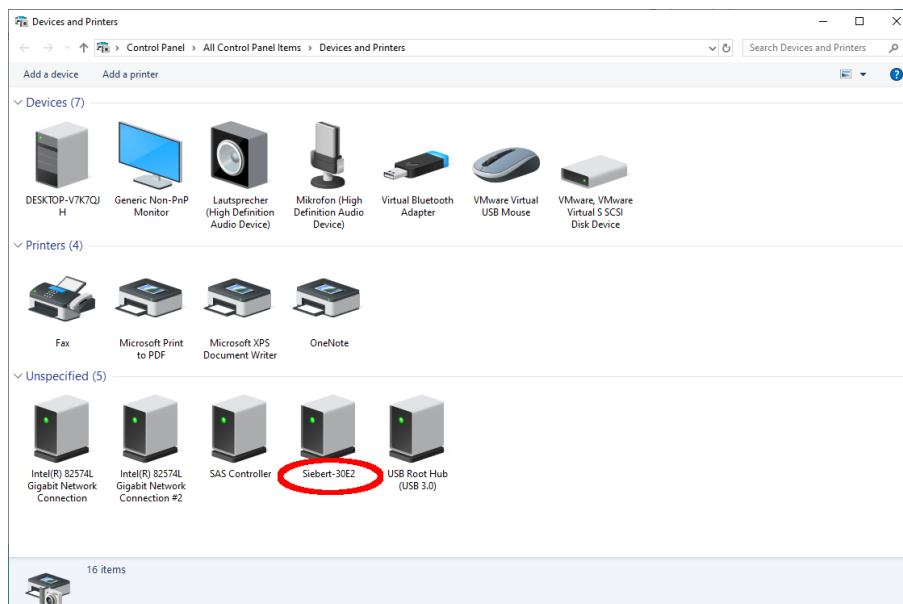

Select the display by double-clicking on it.

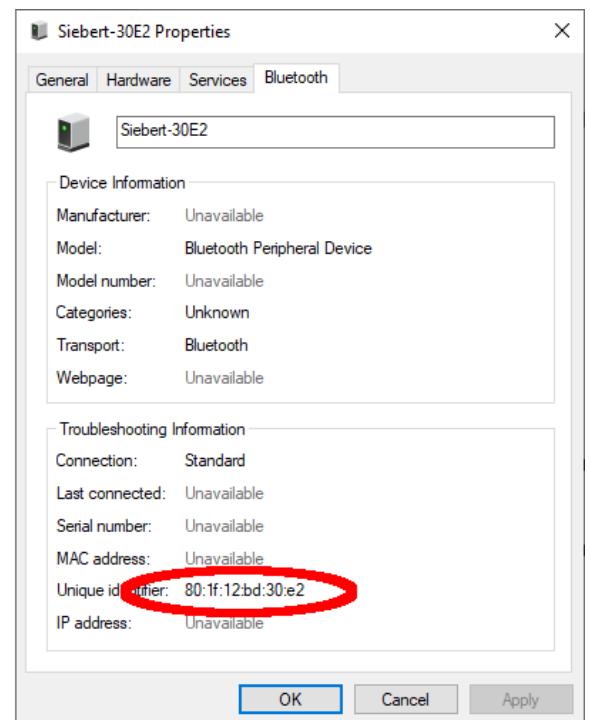
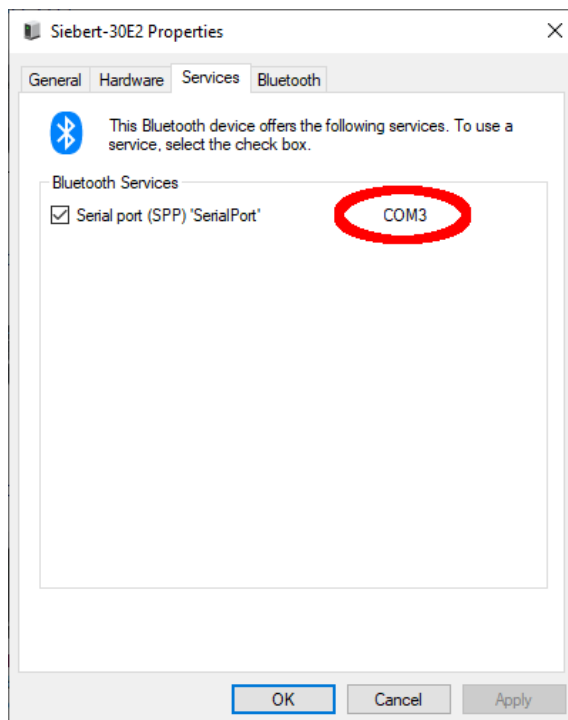

Open the tab 'Services' of the properties dialogue box. The Bluetooth feature 'serial connection (SPP)' has to be activated for the display. The virtual COM port that is used for communication is specified thereafter.

Open the 'Bluetooth tab' of the Properties dialog box. In the line 'Unique ID' you can identify the display.

## Bug fixing

Error description	Solution
The software can not be installed.	<ul style="list-style-type: none"> <li>▪ Make sure that you have admin rights on your PC.</li> <li>▪ Make sure that .NET Framework 4 is installed on your PC.</li> </ul>
The display is not recognized over the network interface.	<ul style="list-style-type: none"> <li>▪ The display is turned off. Turn on the power supply of your display.</li> <li>▪ The network connector is plugged in incorrectly. Check all network connectors. One of the two build in LEDs in each network connector must light permanently.</li> <li>▪ An unsuitable network cable is used. Check if your display needs a cross patch cable or a straight patch cable.</li> <li>▪ The required network ports are blocked by a firewall. Deactivate or configure the firewall.</li> </ul>
The display is not recognized via USB (with displays of type ...-03) or Bluetooth (with displays of type ...-04)	<ul style="list-style-type: none"> <li>▪ The display is off. Turn on the power supply of the display.</li> <li>▪ Check if the Bluetooth coupling between the PC and the display is initialized correctly. Please note the limited range of Bluetooth.</li> </ul>
Error message 'Connection with the display can not be established' (displays with network interface).	<ul style="list-style-type: none"> <li>▪ The TCP-connection is blocked by a firewall. Deactivate or configure the firewall. Ports 8000 and 8100 must be unlocked.</li> <li>▪ Your PC is in a different network segment than the display. Modify the IP-adress of your PC for configuration.</li> </ul>
Error message 'The display does not answer' (displays with serial interface and Bluetooth).	<ul style="list-style-type: none"> <li>▪ Check the serial connection between PC and display.</li> <li>▪ Install the Bluetooth coupling between PC and display.</li> </ul>

---

## 11 Service and Support

---

If you have any questions or want to take advantages of our services, please contact one of the following addresses:

Germany	Siebert Industrieelektronik GmbH Siebertstrasse, D-66571 Eppelborn Phone +49 (0)6806 980-0 Fax +49 (0)6806 980-999 info.de@siebert-solar.com
France	Siebert France Sarl 4 rue de l'Abbé Louis Verdet, F-57200 Sarreguemines BP 90 334, F-57203 Sarreguemines Cédex Phone +33 (0)3 87 98 63 68 Fax +33 (0)3 87 98 63 94 info.fr@siebert-solar.com
Italy	Siebert Italia Srl Via Galileo Galilei 2A, I-39100 Bolzano (BZ) Phone +39 (0)471 053753 Fax +39 (0)471 053754 info.it@siebert-solar.com
The Netherlands	Siebert Nederland B.V. Jadedreef 26, NL-7828 BH Emmen Phone +31 (0)591-633444 Fax +31 (0)591-633125 info.nl@siebert-solar.com
Austria	Siebert Österreich GmbH Mooslackengasse 17, A-1190 Wien Phone +43 (0)1 890 63 86-0 Fax +43 (0)1 890 63 86-99 info.at@siebert-solar.com
Switzerland	Siebert AG Bützbergstrasse 2, Postfach 91, CH-4912 Aarwangen Phone +41 (0)62 922 20 43 (German) Phone +41 (0)62 922 20 44 (French) Phone +41 (0)62 922 2838 (Italy) Fax +41 (0)62 922 33 37 info.ch@siebert-solar.com
Other countries	Please find the addresses as follows: <a href="http://www.siebert-solar.com">www.siebert-solar.com</a>

So that we can help you quickly and efficiently please have the following information ready on demand:

1. Information on the type plate, in particular type and serial number
2. Detailed description of the problem and the circumstances
3. Telephone and fax number and email address under which you can be contracted for queries